

Diamond Porcelain 230mm Marble Stone Concrete Cutting Blade Circular Disc for Manufacturer

Feature:

Diamond Porcelain 230mm Saw Blade

Segment Thickness:	2.6mm
Segment Width:	34.4mm
Size:	230m,9inch
Production Process:	Cold Pressed
Segment Height:	8/10/12mm
Bore Size:	16/20mm,22.23mm,25.4mm,50mm
Application:	Stone, Concrete, Ceramic, Porcelain, Tile, Masonry
Machinery:	Angle Grinder,Circular Saw,Table Saw, Etc.

1.Diamond cutting disc are designed for cutting granite, marble, stone, masonry, hard brick etc.contruction materials

2.Diamond Porcelain 230mm Saw Blade can effectivly remove the chips to enhance the cutting speed.

3.And the cooling holes can cool down the blades to protect the diamond blades for a longer lifespan.

4.This granite diamond cutting disc is characterized by fast cutting and no chipping.

Specification:

The following are normal specifications **Diamond Porcelain 230mm Saw Blade:**

Diameter Inch/mm	Bore Size (mm)	Segment Width (mm)	Segments Thickness (mm)	Segment Height (mm)	4	105	35	1.8	8/10/12
4.3	110	32.3	1.8	8/10/12					
4.5	115	38.5	1.8	8/10/12					
5	125	37.5	2.0	8/10/12					
6	150	33.5	2.2	8/10/12					
7	180	35	2.4	8/10/12					
8	200	39.2	2.4	8/10/12					
9	230	34.4	2.6	8/10/12					

The above specifications is only for reference, other specifications may be available as per customer's demand.

Our factory use original high grade diamond



Other factory mix second diamond selected from waste segment



pk

Our blade cutting effect



Other supplier blade cutting effect

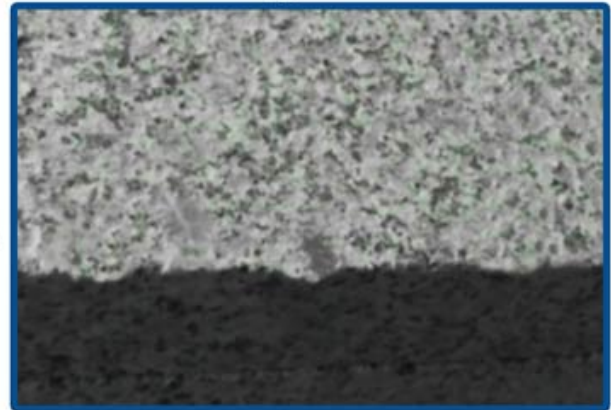

pk

Advantage:

Diamond Porcelain 230mm Saw Blade

1. Hot pressed blade provide long life.
2. Professional quality, very fast cutting.
3. Wet and Dry cutting, chip-free.
4. Can reduce cutting friction a lot, improve slab flatness, save energy.

Factory=Quality Control=Competitive Price=Own technology=OEM

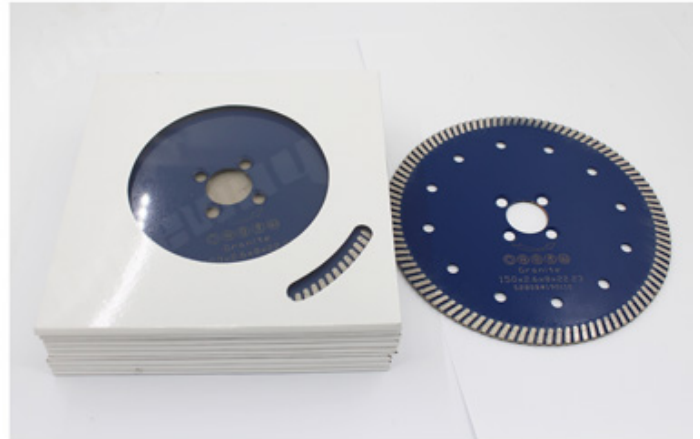
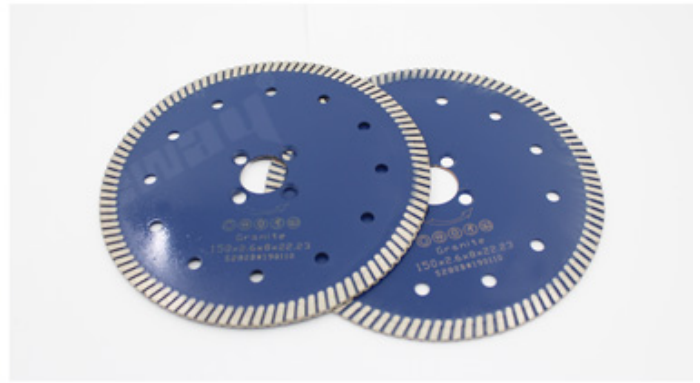
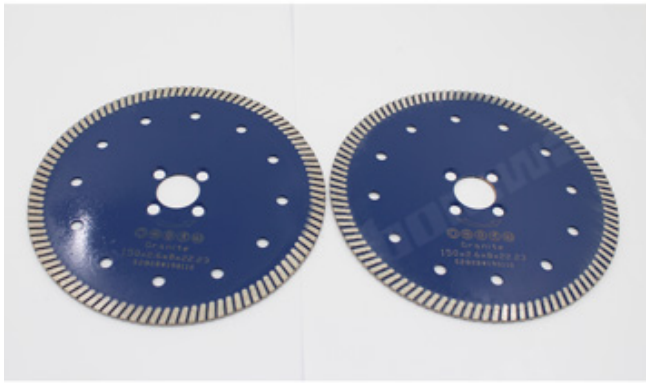

Description:

Diamond Porcelain 230mm Saw Blade is a particularly stable and mature diamond saw blade, especially suitable for cutting ceramics, porcelain, vitrified tiles, granite, stoneware, hard tiles and other stone.

Attention when use:

1. Before saw blade installed, pollutions adhering between saw blade and flange shall be removed,
when installing saw blade, the marked direction shall be kept consistent with the rotating direction of electric tools, and flange shall be fastened by spanner attached to electric tools.
2. Do not use any saw blade that has been deformed for being pressed or crashed.
3. When operating, operator must wear safety helmet, safety footwear and goggles, protective glove, additionally, if necessary operator must use earplug, mask and so on
4. Electric tools shall have protective cover.



● Cold Press Mschine

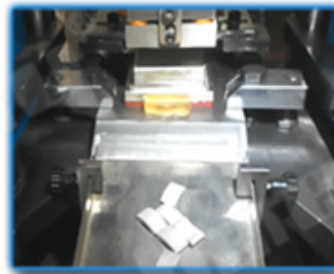

● Fill The Mold



● The Product Polishing



● Remove The Mold



● Hot Press Machinery

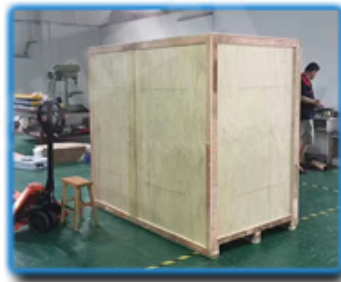
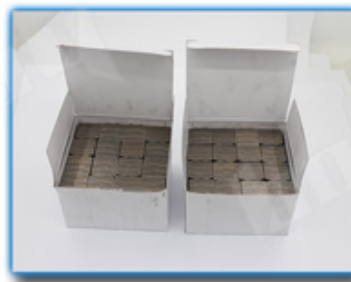

● Packing

Applications:

Hot Sintered, Dry or Wet Use!

Diamond Porcelain 230mm Saw Blade is suitable for kinds of granite, stone, limestone, sandstone, basalt, natural stone, lava stone etc.

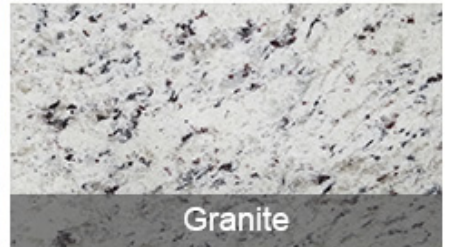
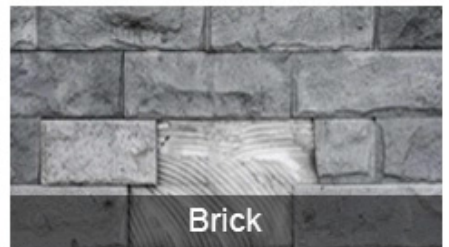
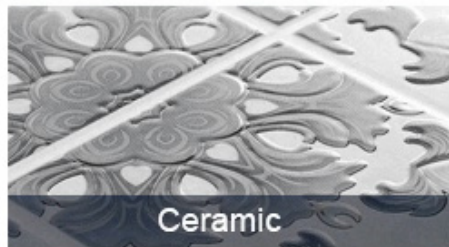
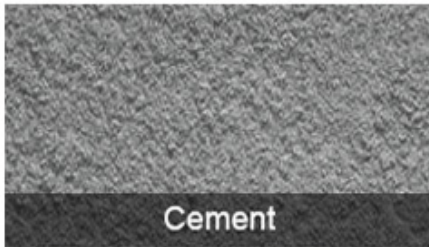

Applications Machine:

Diamond Porcelain 230mm Saw

Blade is use for angle grinder,circular saw,masonry saw,table saw



Electric circular saw



Angle Grinder



Multi-function cutting machine

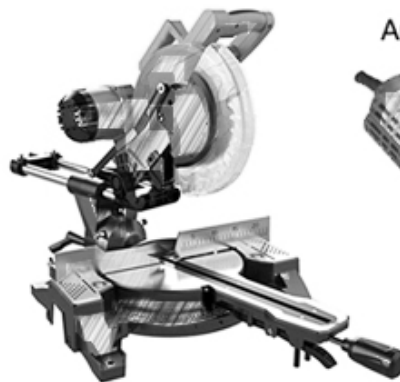

Road cutting machine



Related Products:

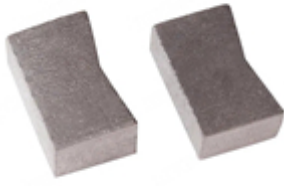

Boreway Machinery Co.,Ltd
www.fordiamondtools.com
www.diamondtools.top

[K Shape Sandwich Structure Diamond Segment](#)



Boreway Machinery Co.,Ltd
www.fordiamondtools.com
www.diamondtools.top

[Wet Use Only Fan Shape Diamond Segment](#)

About us:





Packing □ Delivery:

PS:

1. Tools packing in carton cases
2. By Air/Sea for batch goods, Airport/Port receiving
3. Less than 45kg, generally delivery by express(Door to Door) □
4. When tools are in large quantities, they are packing in wooden cases



Our service:

1. Low order quantity: It can meet the test order you need.
2. Fast delivery: We get great discounts from freight forwarders.
3. OEM Acceptable: We can produce according to your samples or drawings.
4. Good quality: We have a strict quality control system. Has a good reputation in the market.
5. Good service: We regard our customers as God with a high degree of professionalism and enthusiasm.

FAQ:

1. If we want to order your product, how do we know your quality?

You can test with a small order, and then you will know the quality. Nowadays, many people in the world use Chinese products because of their high quality and high cost performance. We are a professional diamond tool manufacturer with more than 8 years of manufacturing experience.

2. Can you provide samples for free?

We do not provide free samples. Based on years of experience, we believe that customers will want them because of their reliable quality. By purchasing samples, we will cherish and appreciate them and make them get more. We are ready to offer our potential customers a special discount on samples. It's very important that you give us feedback, and we will

appreciate it.

3. Does your company accept customization?

Of course, we accept customization. Including different colors, cutting objects, etc. We can also tag your own label and company brand. If you want us to make any new products for you, just send your products to us. Whether it's drawings or samples, we have the ability to produce the same products. We will not sell these products to others, only customers can get permission.

Please note:

Please use high frequency Silver Welded machine instead of Fire to make the brazing, the welding time is only a few seconds, otherwise the diamond inside the segments will probably be damaged by the high temperature, then the cutting performance will be Reduced!

Contact us:

Fujian Nanan **boreway** Machinery Co.,Ltd.



No.605 Huahui Center, Shuitou Town 362342 Quanzhou, Fujian, China



TEL: (+86)595-86990206 /



Fax: (+86)595-86990220



Mobile/WhatsApp/Wechat: (+ 86) 18650679939



E-mail: boreway@boreway.com



Lyon Chang