

## 105mm-230mm Wet Use Turbo Blade Porcelain Ceramic Tile Cutting Disc for Manufacturer

### Advantage:

1. **Wet Use Turbo Blade Porcelain Disc** great adaptability.
2. Cutting method: Wet cutting, Dry cutting.
3. Fast cutting & long life & Stable performance.
4. Working safe, quiet, and precise. reducing cutting & working time.
5. Can reduce cutting friction a lot, improve slab flatness, save energy.

Factory=Quality Control=Competitive Price=Own technology=OEM

### Description:

**Wet Use Turbo Blade Porcelain Disc is usually for cutting Ceramic or Porcelain Tiles.**

**Wet Use Turbo Blade Porcelain Disc** is a particularly stable and mature diamond saw blade, especially suitable for cutting ceramics, porcelain, vitrified tiles, granite, stoneware, hard tiles and other stone.

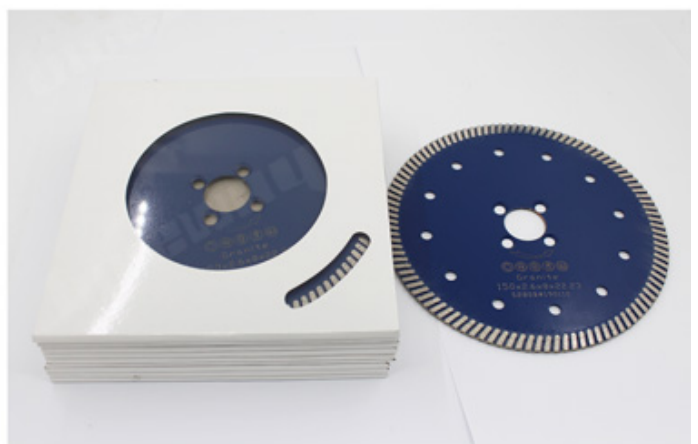
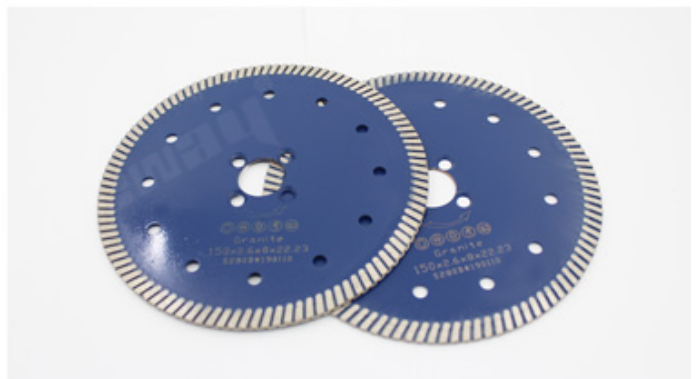
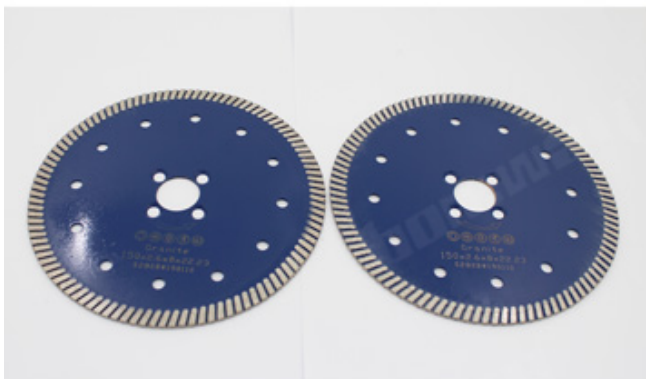

### Feature:

## Wet Use Turbo Blade Porcelain Disc

1. Long working life and superior performance
2. Excellent performance on hard construction material ,reinforced concrete ,brick stone ,smooth cutting on variety tile ,masonry and stone.

**Our factory** use original high grade diamond



pk

**Other factory** mix second diamond selected from waste segment



**Our blade** cutting effect



pk

**Other supplier** blade cutting effect

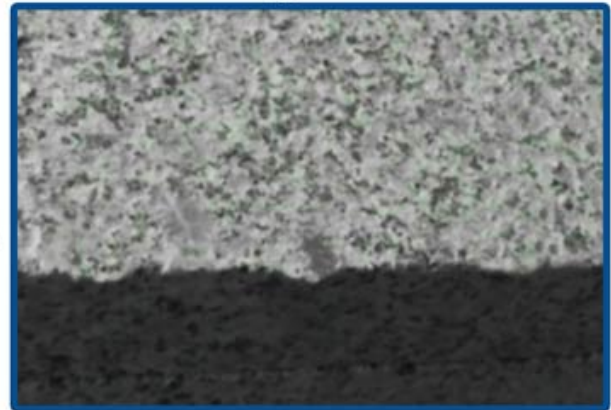

### Specification:

The following are normal specifications **Wet Use Turbo Blade Porcelain Disc:**

Diameter	Bore	Segment		Number of Segments		Segment		4	105	35	6/8	8/10/12
		Thickness (mm)	Side (mm)	Pcs	Height (mm)							
4.3	110	32.3	6/8/9		8/10/12							
4.5	115	38.5	8		8/10/12							
5	125	37.5	9		8/10/12							
6	150	33.5	12		8/10/12							
7	180	35	14		8/10/12							
8	200	39.2	14		8/10/12							
9	220	34.4	18		8/10/12							

The above specifications is only for reference, other specifications may be available as per customer's demand.



Attention when use:

1. Before saw blade installed, pollutions adhering between saw blade and flange shall be removed,  
when installing saw blade, the marked direction shall be kept consistent with the rotating direction of electric tools, and flange shall be fastened by spanner attached to electric tools.
2. Do not use any saw blade that has been deformed for being pressed of crashed.
3. When operating, operator must wear safety helmet, safety footwear and goggles, protective glove, additionally, if necessary operator must use earplug, mask and so on
4. Electric tools shall have protective cover.

### Applications:

**Hot Sintered, Dry or Wet Use!**

Wet Use Turbo Blade Porcelain Disc is suitable for kinds of granite,stone, limestone, sandstone,basalt ,natural stone lava stone etc.

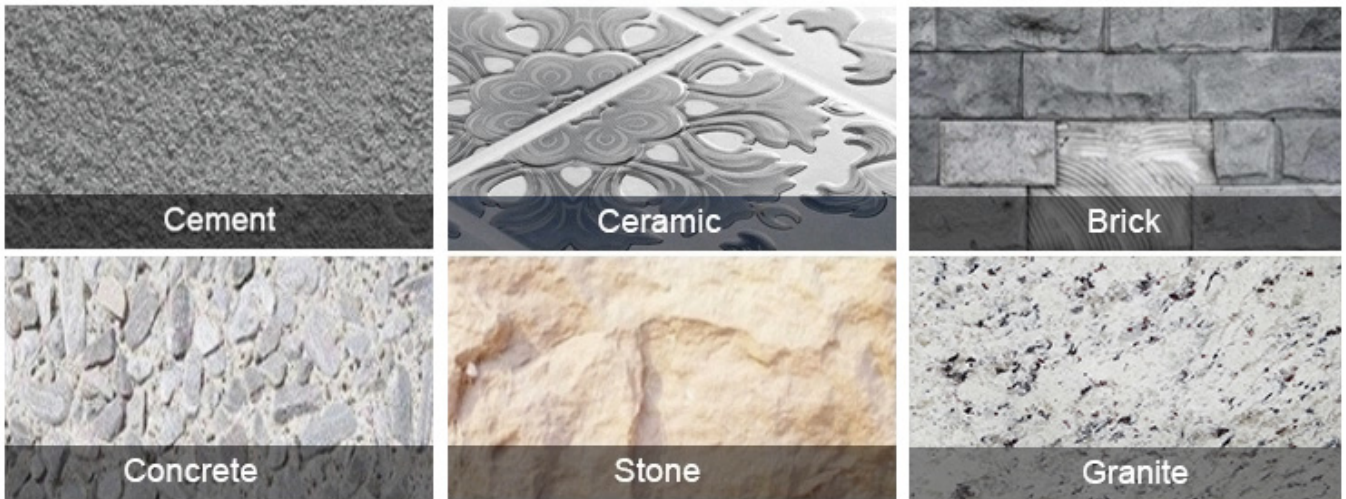

### Applications Machine:

#### Wet Use Turbo Blade Porcelain

Disc use for angle grinder,circular saw,masonry saw,table saw



Electric circular saw

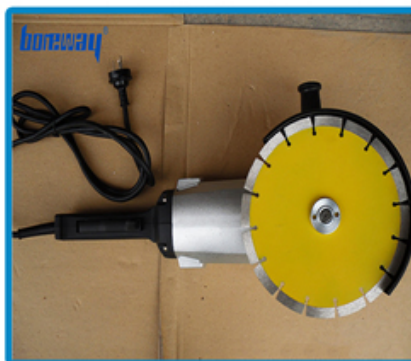

Angle Grinder



Multi-function cutting machine

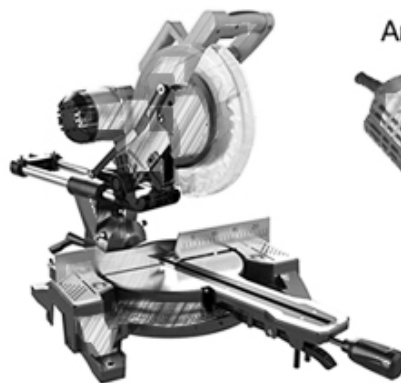

Road cutting machine

### Related Products:



[350mm Arix Matrix Shape Diamond Segment](#)



[Saw Blade Dry Diamond Cutting Disc](#)

**About us:**





## Packing □ Delivery:

Note:

- 1.Tools packing in carton cases
- 2.By Air/Sea for batch goods, Airport/Port receiving
- 3.Less than 45kg, generally delivery by express(Door to Door)□
- 4.When tools are in large quantities, they are packing in wooden cases



## Our service:

1. Low order quantity: It can meet the test order you need.
2. Fast delivery: We get great discounts from freight forwarders.
3. OEM Acceptable: We can produce according to your samples or drawings.
4. Good quality: We have a strict quality control system. Has a good reputation in the market.
5. Good service: We regard our customers as God with a high degree of professionalism and enthusiasm.

## FAQ:

### **1. If we want to order your product, how do we know your quality?**

You can test with a small order, and then you will know the quality. Nowadays, many people in the world use Chinese products because of their high quality and high cost performance. We are a professional diamond tool manufacturer with more than 8 years of manufacturing experience.

### **2. Can you provide samples for free?**

We do not provide free samples. Based on years of experience, we believe that customers will want them because of their reliable quality. By purchasing samples, we will cherish and appreciate them and make them get more. We are ready to offer our potential customers a special discount on samples. It's very important that you give us feedback, and we will

appreciate it.

### 3. Does your company accept customization?

Of course, we accept customization. Including different colors, cutting objects, etc. We can also tag your own label and company brand. If you want us to make any new products for you, just send your products to us. Whether it's drawings or samples, we have the ability to produce the same products. We will not sell these products to others, only customers can get permission.

#### Please note:

Please use high frequency Silver Welded machine instead of Fire to make the brazing, the welding time is only a few seconds, otherwise the diamond inside the segments will probably be damaged by the high temperature, then the cutting performance will be Reduced!

#### Contact us:

Fujian Nanan **boreway** Machinery Co.,Ltd.



No.605 Huahui Center, Shuitou Town 362342 Quanzhou, Fujian, China



**TEL:** (+86)595-86990206 /



**Fax:** (+86)595-86990220



**Mobile/WhatsApp/Wechat:** (+ 86) 18650679939



**E-mail:** [boreway@boreway.com](mailto:boreway@boreway.com)



**Lyon Chang**