

□□ □□ □ □□ □□ □□ □□□□ □□ □□ □□ □□ □□ □□ □□ □□ □□

□□:

□□ = □□ □□ = □□ □□ = □□ □□ = OEM

- 1. □□ □□ : □□ □□, □□ □□.
- 2. □□ □□ □ □ □□, □□□□ □□.

□.□□ □□□ □□□□ □□ □□□□ □□ □□□ □□ □□□, □□□ □□□□ □□□□, □□□□ □□ □ □ □□□□.

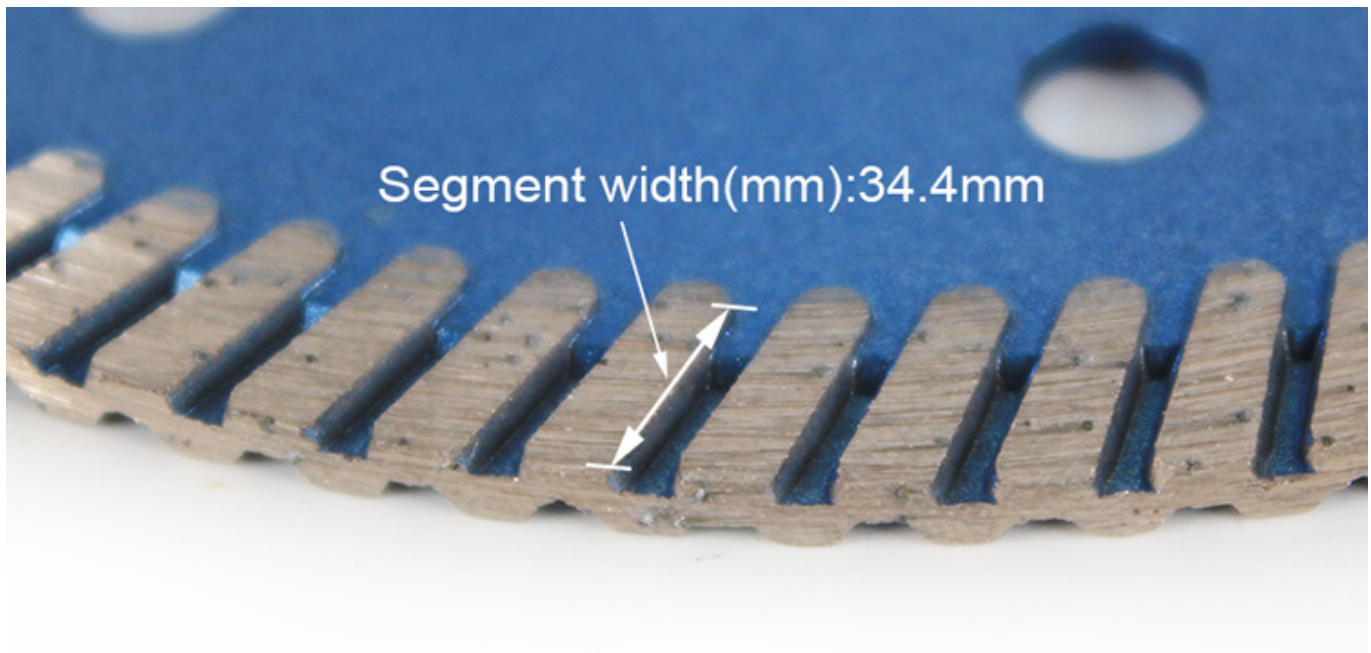



00:

00 000 0000 00 0000 00 000, 000, 00 00, 000, 00, 0000 00 0 00 00 0000 0000 000000 0000 000000 0000 00.

0000 00 :	2.6mm
0000 0 :	34.4mm
00:	230m, 9 00
00 00:	00 000
0000 00 :	8 / 10 / 12mm
00 00 :	16 / 20mm, 22.23mm, 25.4mm, 50mm
00:	0, 0000, 000, 000, 00, 00
00:	00 0000, 00 0, 000 0 0

00:

00 000 0000 00 0000

- 1, 0 000 00 0000 00 0000 00 0 0000 0 00 0000 000000
- 2, 000 (000 1.2mm) 00 00 0 0000 00 0000 00, 0000 0000 00 0000 00 00
- 30 00 00 00 0000, 0000 0000 0000
4. 0000 00 000000 0000 sege00 00000000

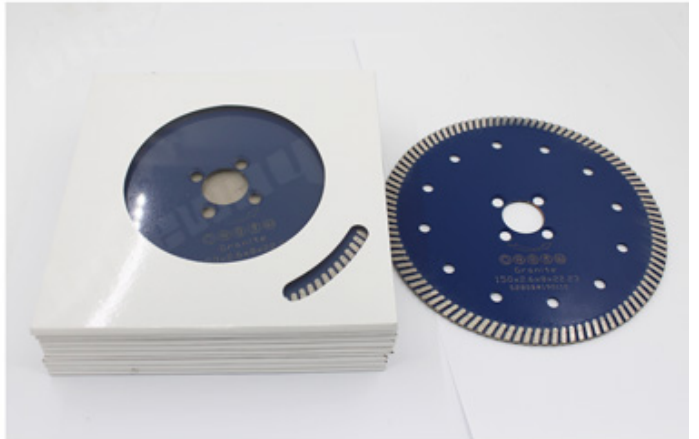
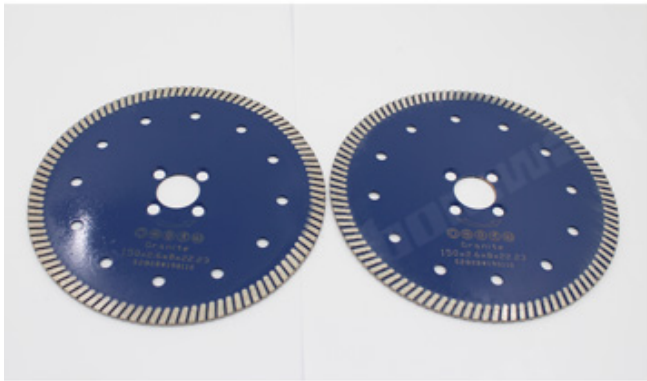

□□ □□□ □□□□ □□ □□ □□□ □□ □□□□ :

□□ □□ □□ □□ □□□ □□ □□ □□ □□ □□ □□ □□ □□ □□□.

□□□□ □□ :

1. □□□ □□□□ □□ □□□ □□□ □□ □□ □□ □□□□□□□.

Our factory use original high grade diamond
Other factory mix second diamond selected from waste segment

1. Our factory use original high grade diamond
2. Other factory mix second diamond selected from waste segment
3. Our blade cutting effect
4. Other supplier blade cutting effect

Our factory use original high grade diamond



pk

Other factory mix second diamond selected from waste segment



Our blade cutting effect



pk

Other supplier blade cutting effect

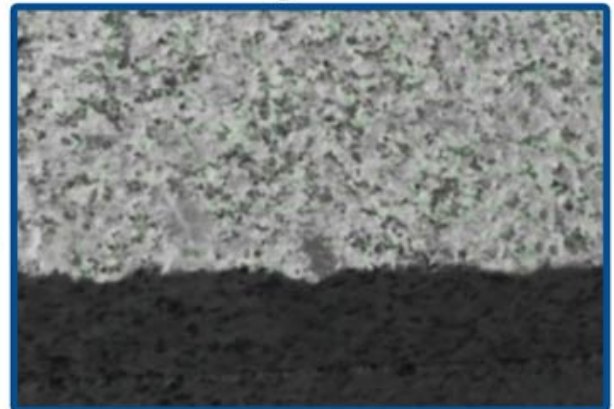

pk :

Our factory use original high grade diamond, Other factory mix second diamond selected from waste segment

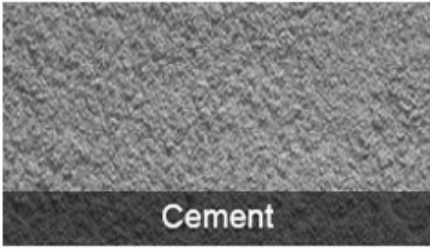

Cement

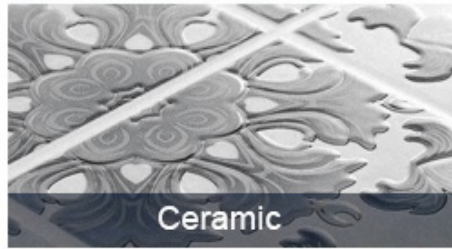

Ceramic

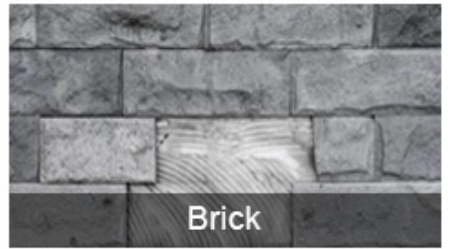

Brick



Concrete



Stone



Granite

□□ □□□□ □□ :

□□ □□, □□ □□ □□ □□!

□□ □□□ □□□□ □□ □□□□ ...□ □□ □□ □□□□, □□ □, □□ □, □□□ □

Electric circular saw



Angle Grinder

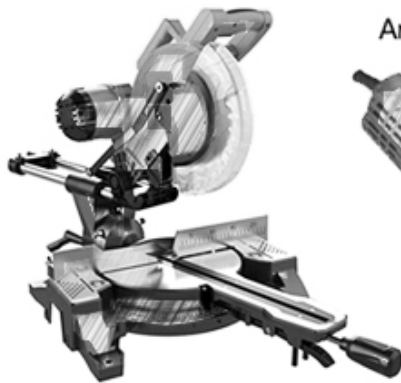

Multi-function cutting machine



Road cutting machine

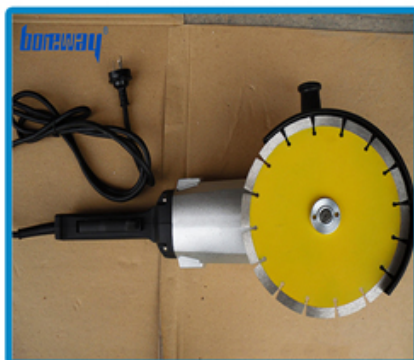

□□ □□:



Boreway Machinery Co.,Ltd
www.fordiamondtools.com
www.diamondtools.top

300mm 00 00 0000 00 00 00000



Boreway Machinery Co.,Ltd
www.fordiamondtools.com
www.diamondtools.top

300mm 0000 00 W 00

0000 00 :

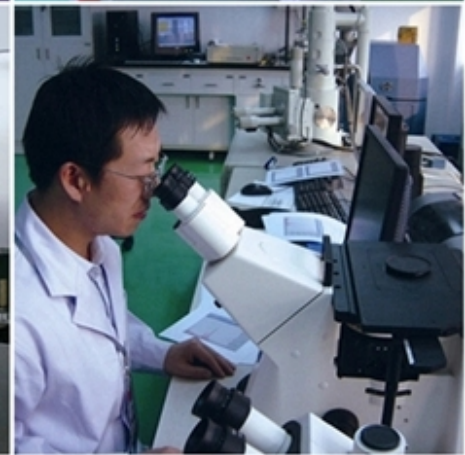



□□ □ □ □ :

□□:

1. □□ □□ □□ □□

□□ □□□□ 2.Air / Sea, □□ / □□

3. 45 □□□□, □□□□ □□ □□□□ (□)

4. □□□ □□ □ □□ □□□□ □□□□□.



□□□ □□□:

1. □□ □□ □□ : □□□ □□□ □□□ □□.
2. □□ □□ :□□ □□□□□□□ □ □□ □□□□□□□.
3. OEM □□ : □□□ □□ □□ □□□ □□ □□ □ □□□□.
4. □□ □□ : □□□ □□□ □□ □□ □□□□ □□□□. □□□□ □□ □□□ □□ □□□□.
5. □□□ □□□ : □□□ □□ □□□ □□□□ □□□ □□ □□□ □□□□□ □□□□□.

□□□□ □□:

- 1. □□□ □□□ □□□ □□□□ □□ □□□, □□□ □□□ □□□ □□ □□□□?**
 □□ □□□□ □□□□□ □□□ □ □□□□. □□□, □□□ □□ □□□□ □□□□ □□ □□ □□□□ □□ □□ □□□ □□□□. □□□ 8 □ □□□ □□ □□□ □□ □□□□□ □□ □□□□□□□.
- 2. □□□ □□ □□□ □□?**
 □□□ □□ □□□ □□□□ □□□□. □□□□ □□□ □□□□ □□□ □□□ □□□ □□ □□□ □□ □□□□ □□□□. □□□ □□□□□□ □□□ □ □□ □□□ □□□ □ □□□□ □ □□□□. □□□ □□ □□□□ □□□ □□ □□□ □□ □ □□□□□□□□□. □□□ □□ □□□ □□□□□□□.
- 3. □□□□ □□□ □□□ □□□□□?**
 □□□, □□□ □□□ □□□ □□□□□□□. □□ □□□, □□ □□ □□ □□□□ □□ □ □□□ □ □□ □□□ □□□ □□□ □□ □□□□. □□□ □□□ □□ □□□ □□□ □□□ □□□□ □□□□ □□□□ □□□□ □□□□□. □□□□ □□□□ □□□□ □□□ □□□ □□□ □ □□□□. □□□ □□□ □□□ □□ □□□□ □ □□□□□□□□ □ □□□□□□ □ □□□□□□ □ □□□□.

☎ :

歡迎各界人士垂詢。如有需要，請洽。竭誠為您服務。如有需要，請洽。竭誠為您服務。如有需要，請洽。

☎☎☎:

Fujian Nanan **boreway** Machinery Co.,Ltd.



No.605 Huahui Center, Shuitou Town 362342 Quanzhou, 福建



☎ : (+86) 595-86990206 /  ☎: (+86) 595-86990220



☎ / **WhatsApp** / **Wechat** : (+ 86) 18650679939



☎☎: **boreway@boreway.com**



☎ ☎