

□□ :

□□□□ □□ □□ □□ □□ □ □□ □□□ □□ □□

□□ □□ : 4500 rpm

□□ □□ : 200 ~ 450mm / min.

- 1. Faster □□□ □□ □□□□□
- 2. □□□ □□ □□□□ □□□□
- 3. □ □□□ □ □□ □□□ □□□.
- 4. □□□□□□ □□ □□□□ □□□□ □□□□□□.



**Boreway Machinery Co.,Ltd**  
[www.diamondtools.top](http://www.diamondtools.top)  
[www.boreway.net](http://www.boreway.net)



**Boreway Machinery Co.,Ltd**  
[www.diamondtools.top](http://www.diamondtools.top)  
[www.boreway.net](http://www.boreway.net)

□□□□□:

BOREWAY □□ □□□□ □□ □□ □□ □□ □□ :

□□:	30mm
□□:	1/2 "G.
□□:	16mm.
□□□□:	□□ □□
□□ □□ :	4500 rpm.
□□:	CNC □□, □□□ □ □□
□□:	□□□ □ □ □□
□□ □□ :	□□□, □□□□□ □ □ □ □□□ □ □□ □□

□□: □□ □□ □□ □□□□□□ □□ □□□ □□ □□□□ □□□□.

□□ □□ □□□ □□ □□ □□□ □□□ □□ □ □ □□□□.

□□ □□ :

1. □□□□□ □□ □□ □□□ □□ □□□ □□□□□□□□ □□□□□ □□ □□ □□, □□ □□ □□, □□□□□ □□ □.
2. □□□, □□□□□ □□ □ □□□, □□□ □, □□ □ □ □□□ □□□□ □□□ □ □□□ □□□□□ □□□ □□□ □□ □□ □□□ □□□□□.
3. □□□ □□□ □ □□□□□ □□ □□ □□□ □□□ □□□□□ CNC □□ □□□ □ □□□ □□ □ □□ □□, □□ □ □□□□ □□□ □□□□□.

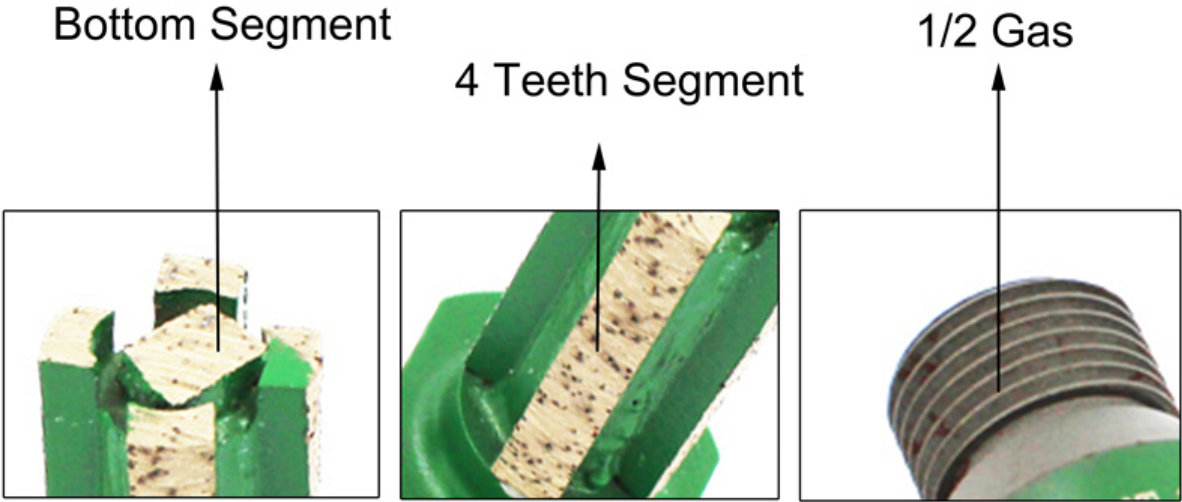

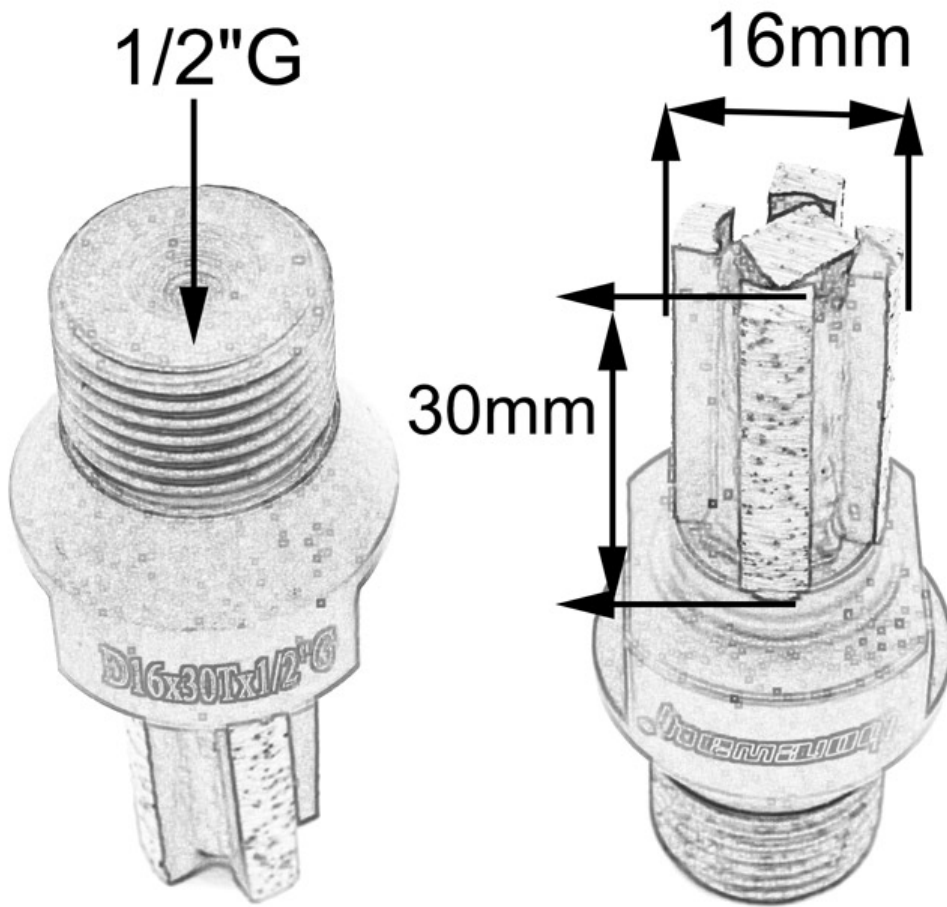

□□:

□□□□ □□ □□ □□ □□ □□□□CNC □□□ □□.

□□ □□□□ □□ □□□□□□ □□□ □□ □□ □□, □□□, □□, □□, □□□ □ □ □□ □□□ □□ □□ □□□□□□.



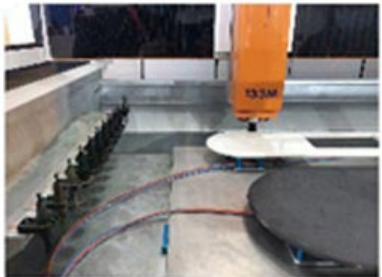
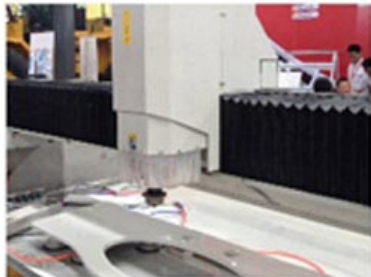
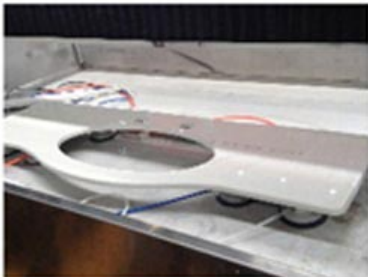
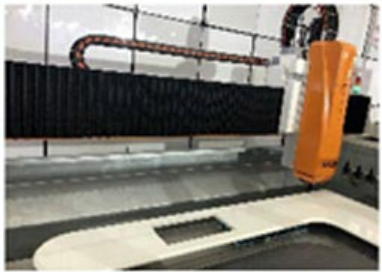

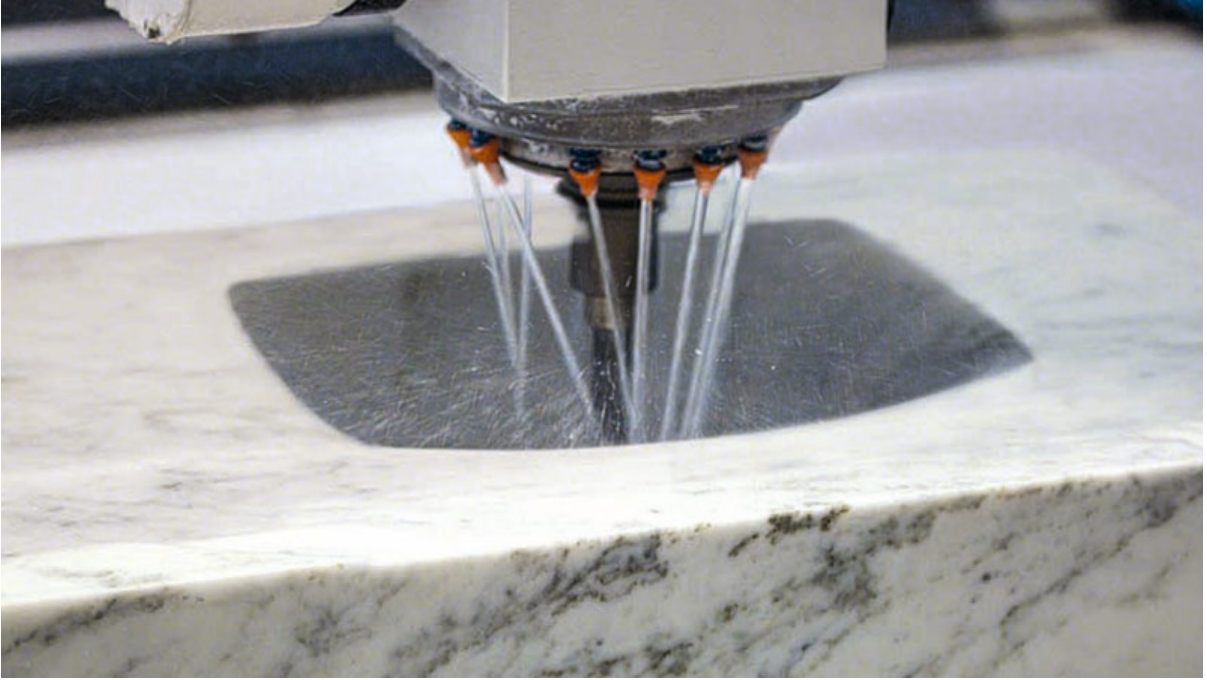

□ □ :





□□□ □□□:

1. □□ □□ □□ : □□□ □□□ □□□ □□□□ □ □□□□.
2. □□ □□ : □□□□□ □□ □□□□□ □ □□□□□□□□.
3. OEM □□ : □□□ □□□ □□□□ □□□ □□ □□□ □ □□□□.
4. □□ □□ : □□□ □□□ □□ □□ □□□□ □□□ □□□□. □□□□ □□ □□□ □□ □□□□.
5. □□ □□□ : □□□ □□□ □□ □□□ □□□□ □□□□ □□□□□□ □□□□□.

□□ □□:

DHL, UPS, □□□, TNT, EMS □□ □□ □□ □□□

□□ □□ □□□□ □□□□ exwork, FOB, CNF, CIF □□ □□ □□□□ □□□ □□ □□□ □□□ □□ □□□□.



- For sample or small orders, products could be sent by express, TNT, DHL, UPS, FedEx, EMS etc.
- For large orders, shipping by sea or air is recommended. By our long-term cooperate agent or your appointed forward.
- By sea, port of loading: Shanghai, Ningbo, Xiamen, Qingdao etc.



□□□□ □□:

**1. □□□ □□□□ □□□ □□□ □□□ □ □ □□□□?**

□□ □□ □□□ □□□ □ □□ □□□□□□. □□ □□ □□□ □□ □□□□□ □□ □□□ □□□ □□ □□□□ □□□□. □□□ □□ □□□□□ □□□ □□□ □□ □□□□□ □ □□□□□.

**2. □□ □□□ □□ □ □ □□□□?**

□□□ □□ □□□ □□□□. □□□ □□□□ □□□ □□□□ □□□□ □□□ □□□ □□□ □□□ □□□□□□. □□□ □ □□ □□□ □ □□ □ □□□□. □□□ □□□ □□ □□□□ □□□□ □□□□ □□□ □□□ □□□ □□□□□□. □□□□ □□□□□□ □□ □□ □□□□□. □ □□ □□□ □□□ □□□□□.

**3. □□□ □□ □□□ □□□□□?**

□□□, □□□ □□□ □□□□□□□. □□□, □□ □□ □□□□ □□□ □□□ outlogo □□□□ □□□ □□ □ □ □□□□. □□□ □□□ □□□ □□□ □□ □□□□□ □□□□, □□□□ □□□□ □□□ □□ □□□, □□□ □□ □□ □□□ □□□□. □□□ □□□ □□□□□ □□□□ □□ □□□ □□ □□ □□□□ □□□□ □□ □□□□.

□□ □□ :

1. □□□□ □□ □□□ □□□□□□□.
2. □□□□ □□ □□ □□□ □□□□□□□.
3. □□ □□□ □□ □□□ □□ □□□ □□ □ □ □□□□.

□□□□:

**Fujian Nanan *boreway* Machinery Co.,Ltd.**

No.605 Huahui Center, Shitou Town 362342 Quanzhou, Fujian, China.

□□ : (+86) 595-86990206 / □□:(+86) 595-86990220

□□□ / **WhatsApp / Wechat** :(+ 86) 18650679939.



 **☐☐☐: boreway01@boreway.com.**

 **Lyon Chang.**