

9. The product is a circular saw blade with a narrow tooth continuous turbo rim. It is made of blue metal and has several holes in the center. The blade is shown in various views, including a close-up of the teeth and a view of the blade in its packaging.

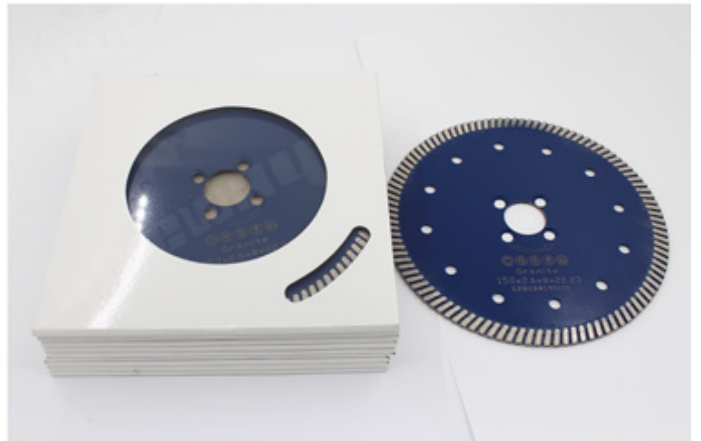

9. The product is a circular saw blade with a narrow tooth continuous turbo rim. It is made of blue metal and has several holes in the center. The blade is shown in various views, including a close-up of the teeth and a view of the blade in its packaging.

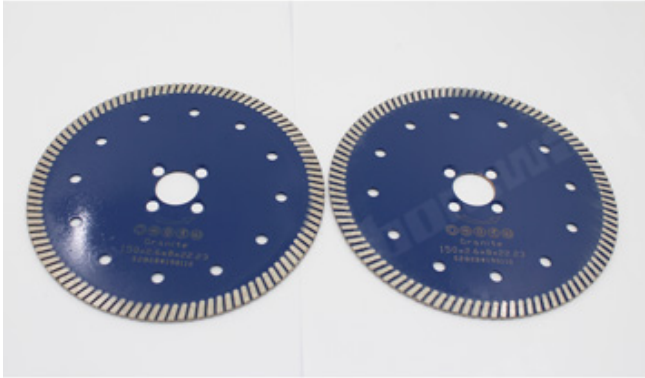

□□:

1. □□ □□ : □□ □□, □□ □□.

2. □□ □□ □ □ □□ □ □□□ □□.

□□□□, □□□□, □□□ 3.Working □□ & □□ □□.

4.9 □□ □□□□□ □□ □□□□ □□ □□□ □□ □□□ □□ □□□, □□□ □□□□ □□□□, □□□□ □□ □ □ □□□□.

□□:

□□□ □□□□ □□□□□ 9 □□ □□□□□ □□ □□□□ □□ □□□□ :

□□	□□	□□	□□□□	□□	□□	□□	□□	□□	□□
□□(mm)	□□ (mm)	□□ (mm)	□□□□ (mm)	□□□□ (mm)	□□ (mm)	□□	□□	□□	□□□□□□
43	33.0	32.3	1.8	8/10/12	4	105	35	1.8	8/10/12
45	31.5	30.5	1.8	8/10/12					
5	125	37.5	2.0	8/10/12					16/20 22/23 25/4 50
6	150	33.5	2.2	8/10/12					
7	180	35	2.4	8/10/12					
8	200	39.2	2.4	8/10/12					
9	230	34.4	2.6	8/10/12					

□□ □□□ □□ □□ □□□ □□□ □□□ □□ □□ □□□ □□ □□□□.

□□□□□ □□ :

1. □□□ □□□□ □□ □□□ □□□ □□□ □□ □ □ □□ □□□□□□□□.

□□□ □□□ □ □□□ □□□ □□□ □□□□□□□□□□  
□□ □□□ □□□ □□□ □□ □□□ □□□□□□□□□□.

2. □□□ □□ □□ □ □□□ □□□□ □□□□.

3. □□□ □□□□ □□ □□, □□ □□ □ □□□, □□ □□□ □□□□□□□, □□□ □□ □□□□ □□□, □□□ □□ □□□□□□□□.

4. □□ □□□□ □□ □□□ □□□□□□□.

□□:

9 □□ □□□□□ □□ □□□□ □□ □□□□

1. □□□□ □□

2. □□ □□ □□

□. □□□ □□ □□

4. □□ □□□ □□□□ □□ □□ □□□

□□ = □□ □□ = □□ □□ = □□ □□ = OEM

**Our factory** use original high grade diamond



**Other factory** mix second diamond selected from waste segment



pk

**Our blade** cutting effect



**Other supplier** blade cutting effect

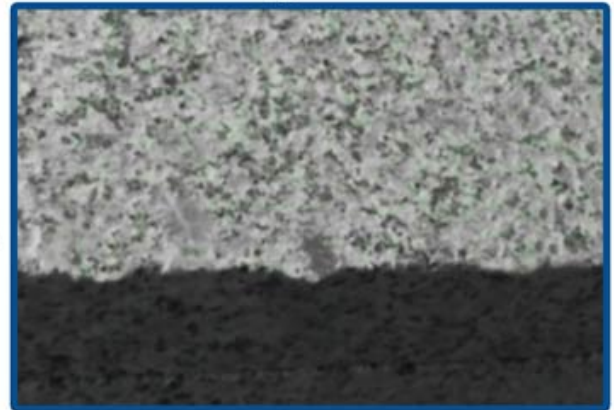

pk

□□ □□ □□:

9 □□ □□□□ □□ □□□□ □□ □□□



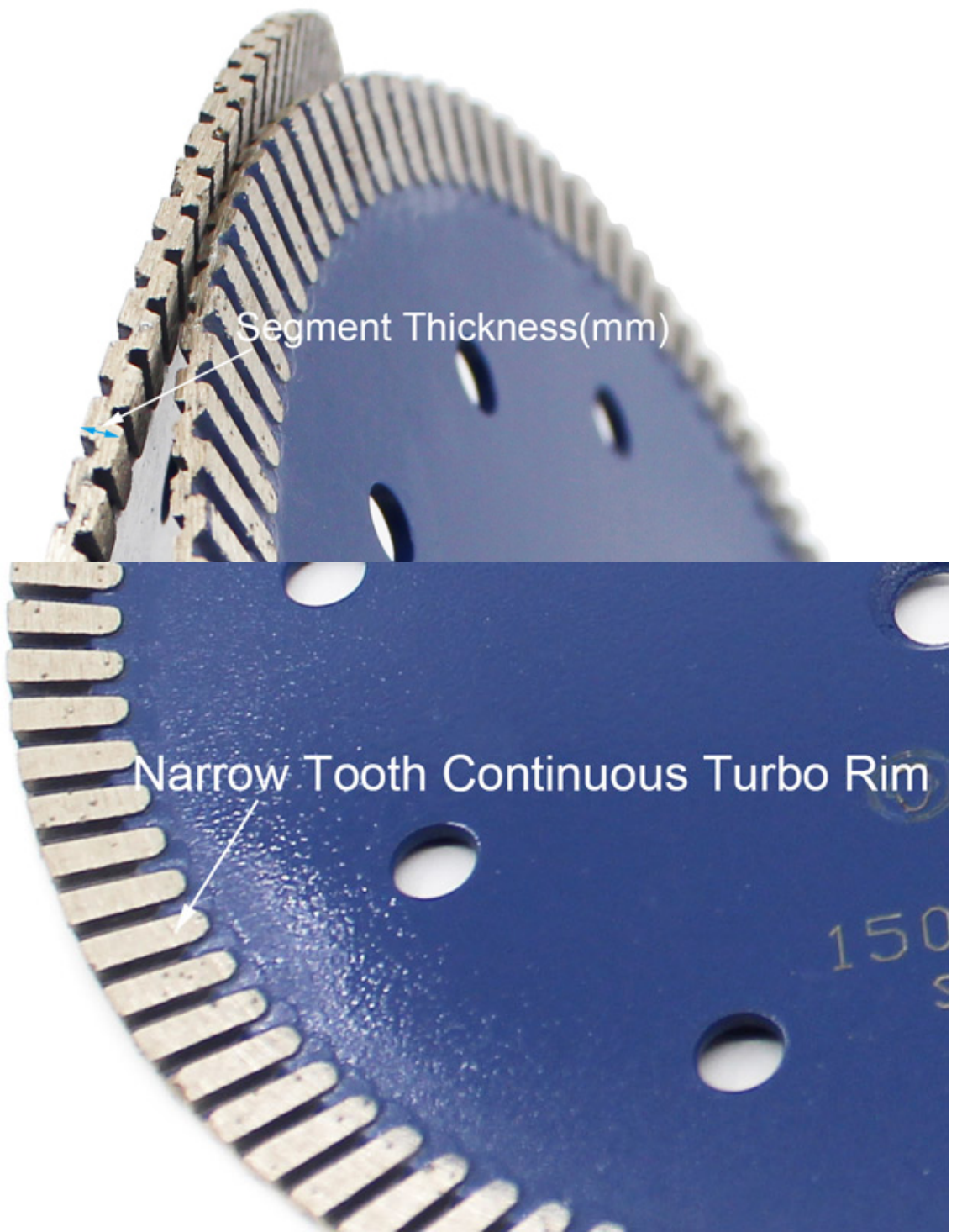

Segment Thickness(mm)

Narrow Tooth Continuous Turbo Rim

150  
S

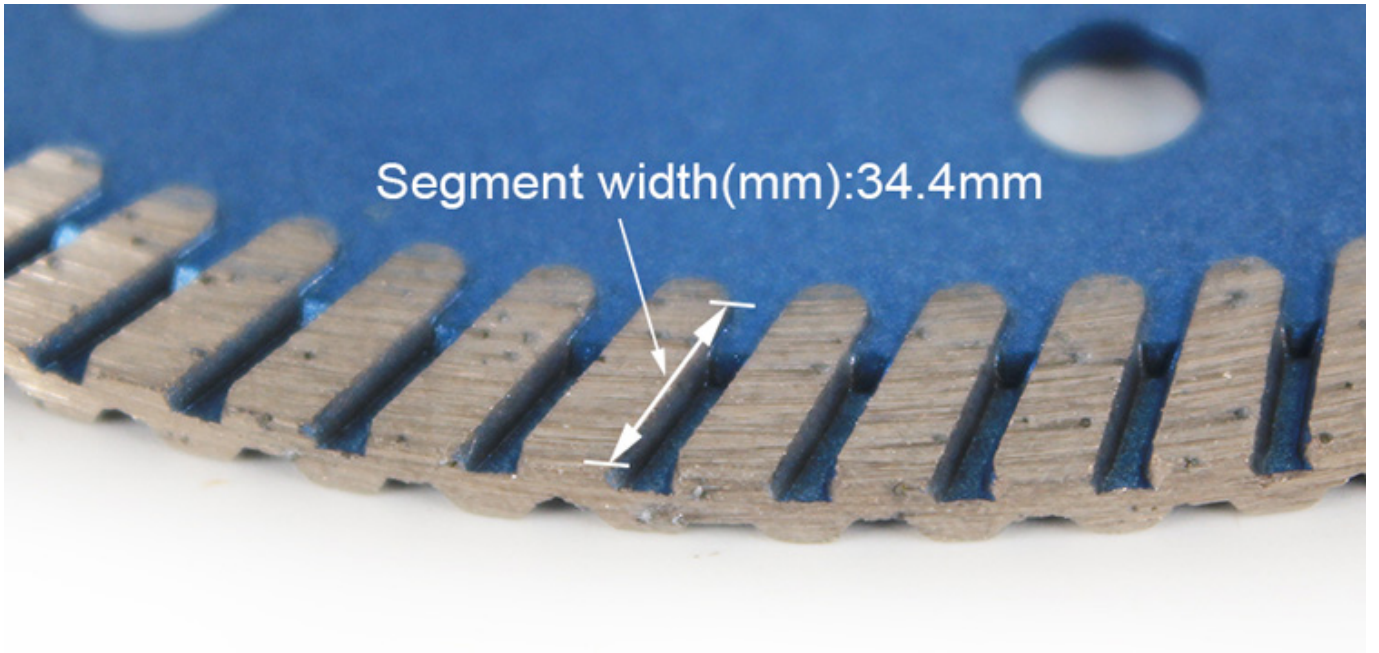

□□ :

□□ □□, □□ □□ □□ □□!

9 □□ □□□□□ □□ □□□□ □□ □□□ □□□, □, □□□, □□, □□□, □□□ □□ □ □□ □□□ □□□□□□.

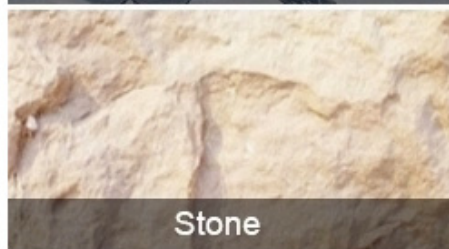
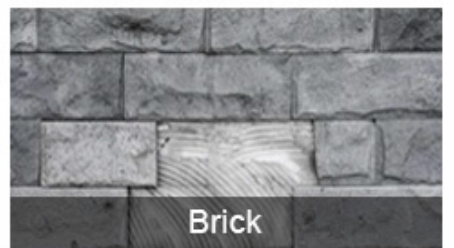
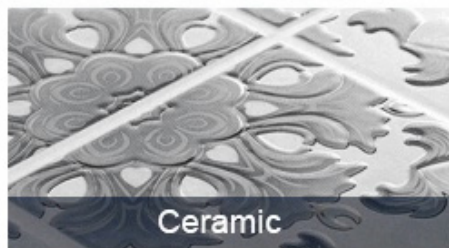
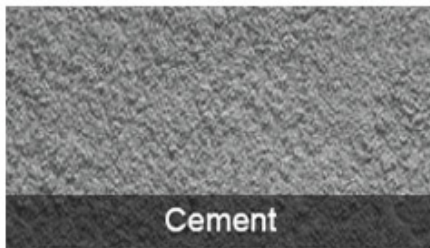

□□ □□□□ □□ :

9 □□ □□□□□ □□ □□□□ □□ □□□ □□□□ ...□ □□ □□ □□□□□, □□ □, □□ □, □□□ □

Electric circular saw



Angle Grinder



Multi-function cutting machine

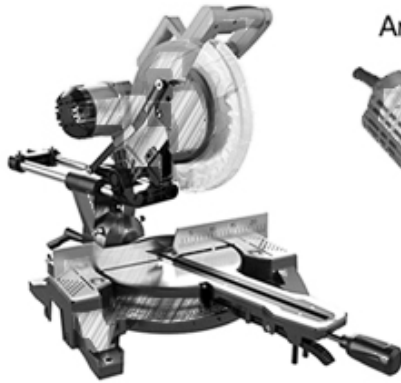

Road cutting machine

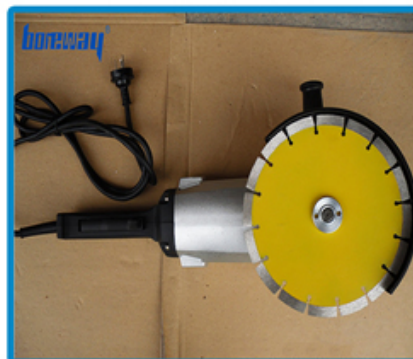

□□ □□ :



Boreway Machinery Co.,Ltd  
www.diamondtools.top  
www.boreway.net

1200mm □□□□ □□ □□□□□□ □

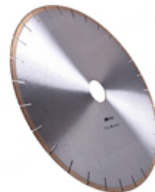

Boreway Machinery Co.,Ltd  
www.diamondtools.com  
www.diamondtools.top

350mm □□□□ □□□□□□ □□ □□□□ □

□□□ □□ :







□□ □ □ □ :

□□:

1. □□ □□ □□ □□

□□ □□□□ 2.By □□ / □□, □□ / □□ □□

3. 45 □□□□, □□□□ □□ □□□□ (□)

4. □□□ □□ □ □□ □□ □□□□ □□□□.





**ᐱᐱᐱ ᐱᐱᐱ:**

1. ᐱᐱ ᐱᐱ ᐱᐱ : ᐱᐱᐱ ᐱᐱᐱ ᐱᐱᐱ ᐱᐱ.
2. ᐱᐱ ᐱᐱ :ᐱᐱ ᐱᐱᐱᐱᐱᐱ ᐱ ᐱᐱ ᐱᐱᐱᐱᐱᐱ.
3. OEM ᐱᐱ : ᐱᐱᐱ ᐱᐱ ᐱᐱ ᐱᐱᐱ ᐱᐱ ᐱᐱ ᐱ ᐱ ᐱᐱᐱᐱ.
4. ᐱᐱ ᐱᐱ : ᐱᐱᐱ ᐱᐱᐱ ᐱᐱ ᐱᐱ ᐱᐱᐱᐱ ᐱᐱᐱᐱ. ᐱᐱᐱᐱ ᐱᐱ ᐱᐱᐱ ᐱᐱ ᐱᐱᐱᐱ.
5. ᐱᐱ ᐱᐱᐱ : ᐱᐱᐱ ᐱᐱ ᐱᐱᐱ ᐱᐱᐱᐱ ᐱᐱᐱ ᐱᐱ ᐱᐱᐱ ᐱᐱᐱᐱᐱ ᐱᐱᐱᐱᐱ.

**ᐱᐱᐱᐱ ᐱᐱ:**

1. ᐱᐱᐱ ᐱᐱᐱ ᐱᐱᐱ ᐱᐱᐱᐱ ᐱᐱ ᐱᐱᐱ, ᐱᐱᐱ ᐱᐱᐱ ᐱᐱᐱ ᐱᐱ ᐱᐱ ᐱᐱᐱᐱ?  
 ᐱᐱ ᐱᐱᐱᐱ ᐱᐱᐱᐱᐱ ᐱᐱᐱ ᐱ ᐱ ᐱᐱᐱᐱ. ᐱᐱᐱ, ᐱᐱᐱ ᐱᐱ ᐱᐱᐱᐱ ᐱᐱᐱᐱ ᐱᐱ ᐱᐱ ᐱᐱᐱᐱ ᐱᐱ ᐱᐱ ᐱᐱᐱ ᐱᐱᐱᐱᐱ. ᐱᐱᐱ 8 ᐱ ᐱᐱᐱ ᐱᐱ ᐱᐱᐱ ᐱᐱ ᐱᐱᐱᐱᐱ ᐱᐱ ᐱᐱᐱᐱᐱᐱ.
2. ᐱᐱᐱ ᐱᐱ ᐱᐱᐱ ᐱᐱ?  
 ᐱᐱᐱ ᐱᐱ ᐱᐱᐱ ᐱᐱᐱᐱ ᐱᐱᐱᐱ. ᐱᐱᐱᐱ ᐱᐱᐱ ᐱᐱᐱᐱ ᐱᐱᐱ ᐱᐱᐱ ᐱᐱᐱ ᐱᐱᐱ ᐱᐱ ᐱᐱᐱ ᐱᐱᐱᐱ ᐱᐱᐱᐱ. ᐱᐱᐱ ᐱᐱᐱᐱᐱᐱ ᐱᐱᐱ ᐱ ᐱᐱ ᐱᐱᐱ ᐱᐱᐱ ᐱ ᐱᐱᐱᐱᐱ. ᐱᐱᐱ ᐱᐱ ᐱᐱᐱᐱ ᐱᐱᐱ ᐱᐱ ᐱᐱ ᐱᐱᐱ ᐱᐱ ᐱ ᐱᐱᐱᐱᐱᐱᐱ. ᐱᐱᐱ ᐱᐱ ᐱᐱᐱ ᐱᐱᐱᐱᐱᐱ.
3. ᐱᐱᐱᐱ ᐱᐱᐱ ᐱᐱᐱ ᐱᐱᐱᐱᐱ?  
 ᐱᐱ, ᐱᐱᐱ ᐱᐱᐱ ᐱᐱᐱ ᐱᐱᐱᐱᐱᐱ. ᐱᐱ ᐱᐱ, ᐱᐱ ᐱᐱ ᐱᐱ ᐱᐱᐱᐱ ᐱᐱᐱ ᐱᐱ ᐱᐱᐱ ᐱᐱᐱᐱ ᐱᐱ ᐱᐱᐱᐱ ᐱᐱᐱ ᐱᐱᐱ ᐱᐱᐱ ᐱ ᐱᐱᐱᐱ. ᐱᐱᐱ ᐱ ᐱᐱ ᐱᐱ ᐱᐱᐱ ᐱᐱᐱ ᐱᐱᐱ ᐱᐱᐱ, ᐱᐱᐱᐱ ᐱᐱᐱ ᐱᐱᐱᐱᐱ. ᐱᐱᐱᐱ ᐱᐱᐱᐱ ᐱᐱᐱᐱ ᐱᐱᐱ ᐱᐱᐱ ᐱᐱᐱ ᐱ ᐱᐱᐱᐱ. ᐱᐱᐱ ᐱᐱᐱ ᐱᐱᐱ ᐱᐱ ᐱ ᐱᐱᐱᐱᐱ ᐱᐱ ᐱᐱᐱᐱᐱ.

☎ :

本公司 專營 各種 機械 設備 代理 銷售 服務 週到。 竭誠 歡迎 各界 人士 垂詢。 詳情 請洽 本公司 業務 經理 先生 或 女士 洽談。 電話 號碼 如下：

☎☎☎☎:

Fujian Nanan *boreway*® Machinery Co.,Ltd.



No.605 Huahui Center, Shuitou Town 362342 Quanzhou, 中國



☎ : (+86) 595-86990206 /



☎: (+86) 595-86990220



☎☎ / **WhatsApp** / **Wechat** : (+ 86) 18650679939



☎☎: **boreway@boreway.com**



☎☎