

Cooling Holes

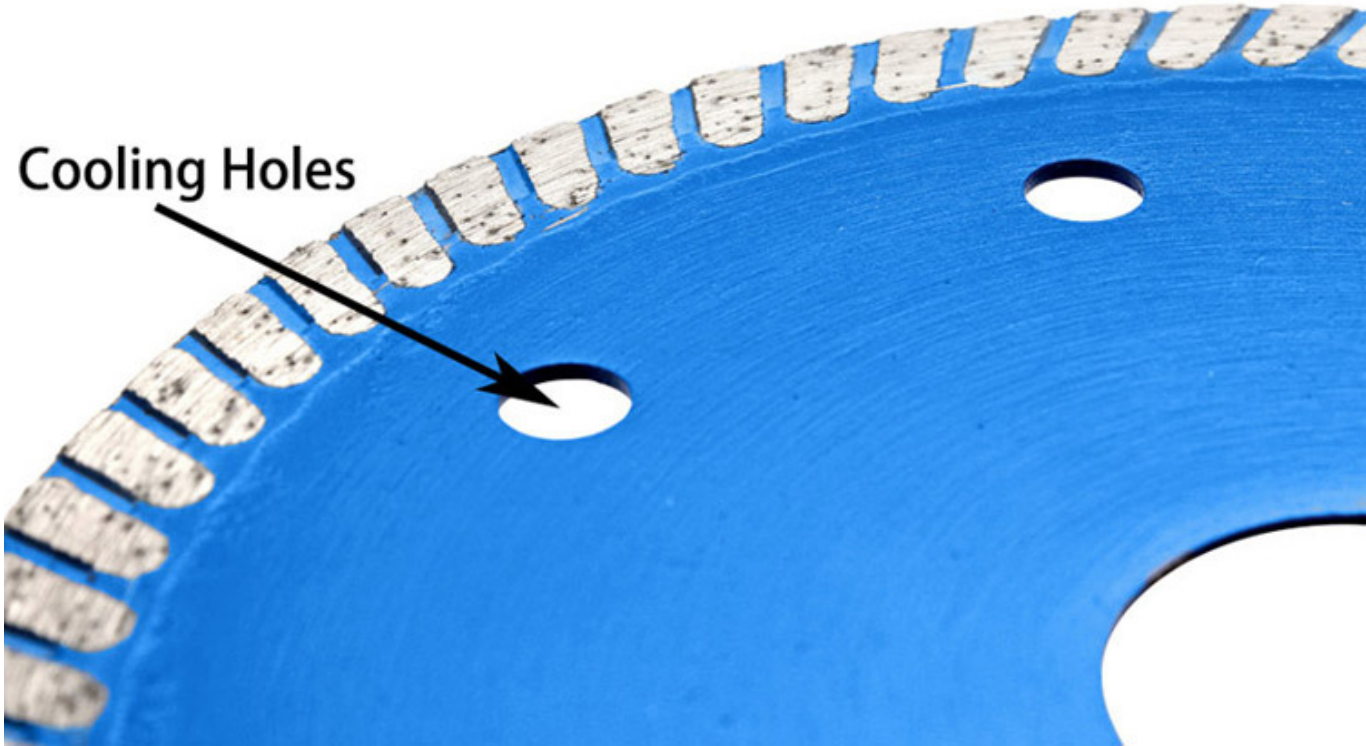



□□□

1. □□□□□□□□□□□□□□□□

2. Fast□□&□□□&□□□□□□□□□□□□

3. □□□□□□□□□□□□□□□□□□□□□□□□

4. □□□□□□□□□□□□□□□□□ □□□□□□□

5. □C□□□□□□□□□□□□□□□□□□□□□□□□□□

□□=□□□□=□□□□□□□□=□□□□= OEM

Our factory use original high grade diamond



pk

Other factory mix second diamond selected from waste segment



Our blade cutting effect



pk

Other supplier blade cutting effect

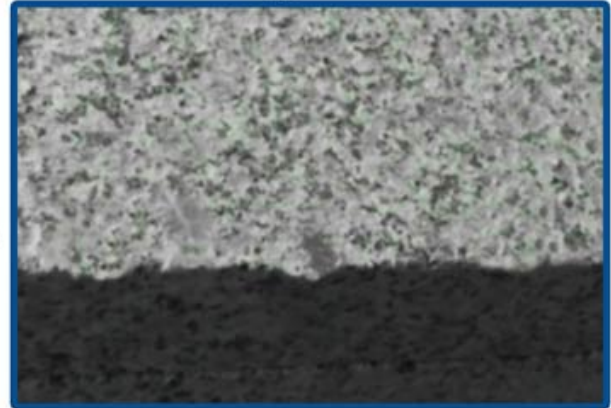

□□□□□□□□ □□□□□□□□□□□□□□□□□□□□□□□□

00	0000	0000	0000	0000	4	105	35	1.8	8/10/12
4.3	110	32.2	1.8	8/10/12					
4.5	115	38.5	1.8	8/10/12					
5	125	37.5	2.0	8/10/12					
6	150	33.5	2.2	8/10/12					
7	180	35	2.4	8/10/12					
8	200	39.2	2.4	8/10/12					
9	230	34.4	2.6	8/10/12					

1620
22.23
25.4
50

□□□□□□□□□□□□□□□□□□□□□□□□□□□□□□□□

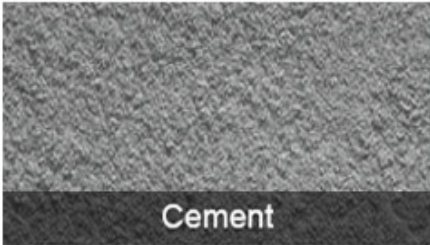

Cement

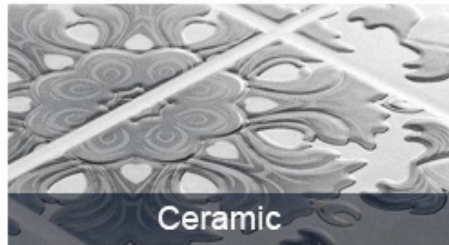

Ceramic

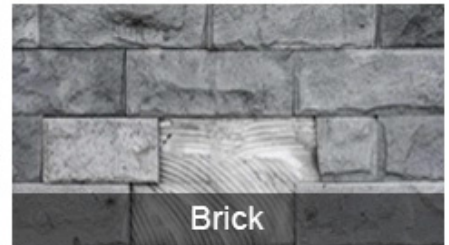

Brick



Concrete



Stone



Granite

□□□□□□□□□□

□□□□□□□□□□□□□□□□ □□□ □□□ □□□□□□□□□□□□□□□□□□□□□□□□□□□□



Electric circular saw



Angle Grinder



Road cutting machine



Multi-function cutting machine

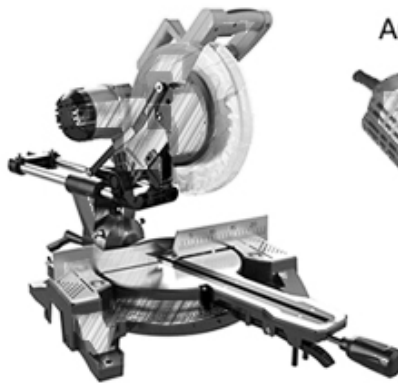

□□□□

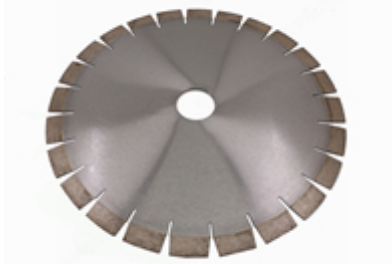

Boreway Machinery Co., Ltd.
www.diamondtools.top
www.boreway.com

D350 * 3.2 * 20 * 40mm * 50 / 60mm Slient

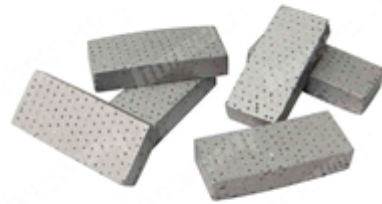

Boreway Machinery Co.,Ltd
www.diamondtools.top
www.boreway.net

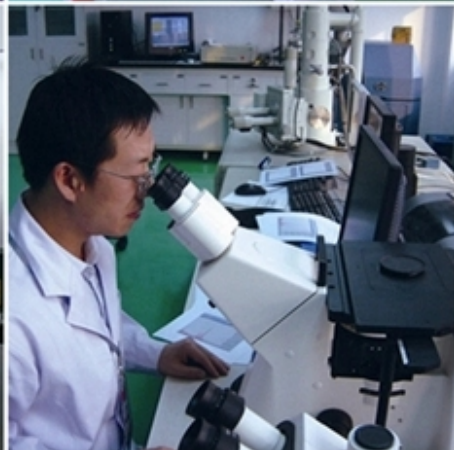



□□&□□□

PS□

1. □□□□□□□□□□□□□□□□

□□□□□□2. Air / Sea □□□□□□□□/□□□□□□□□

3. 45kg □□□□□□□□□□□□□□□□□□□□□□□□□□□□

4. □□□□□□□□□□□□□□□□□□□□□□□□□□□□□□□□

