

CNC D50mm

- 1.
- 2.High
- 3.
- 4.

CNC D50mm

50mm	45mm	5/8 "-11

bw-z z - M01.	25mm 1 "	35mm 40mm 45mm	M14 M16 5/8 "-11 1/2 "G.
	50mm 2 "		
	75mm 3 "		
	100mm 4 "		

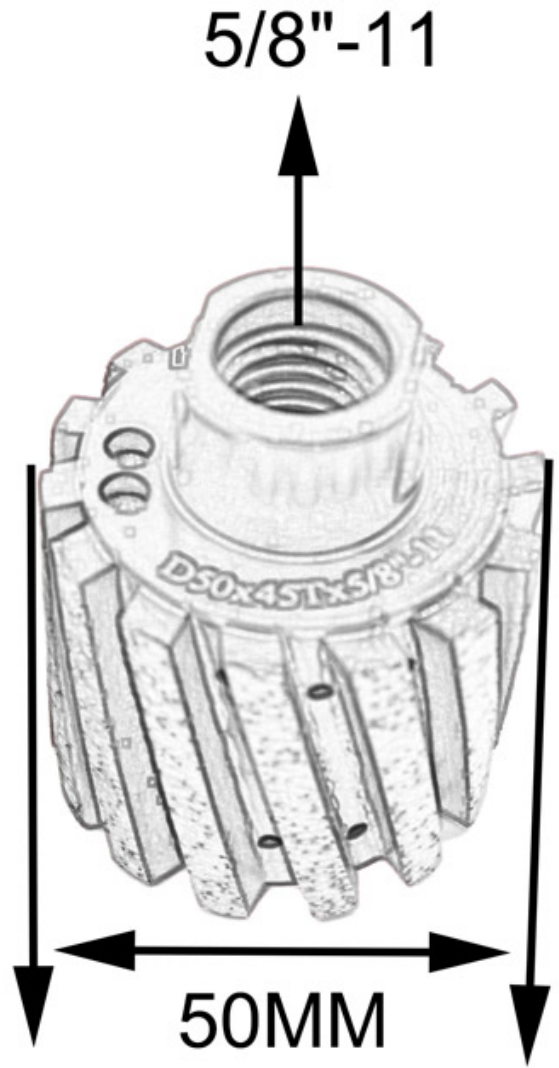
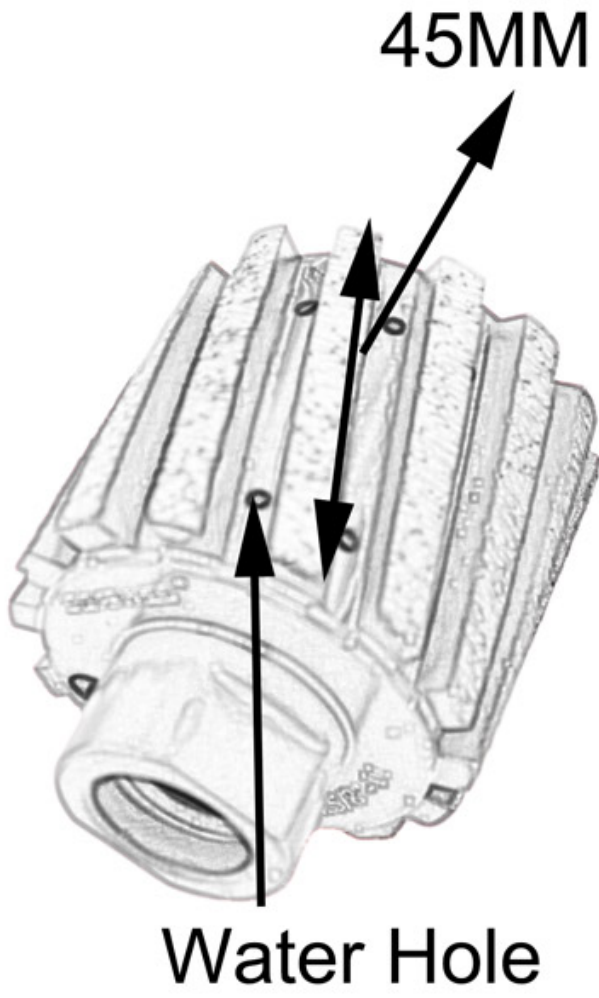

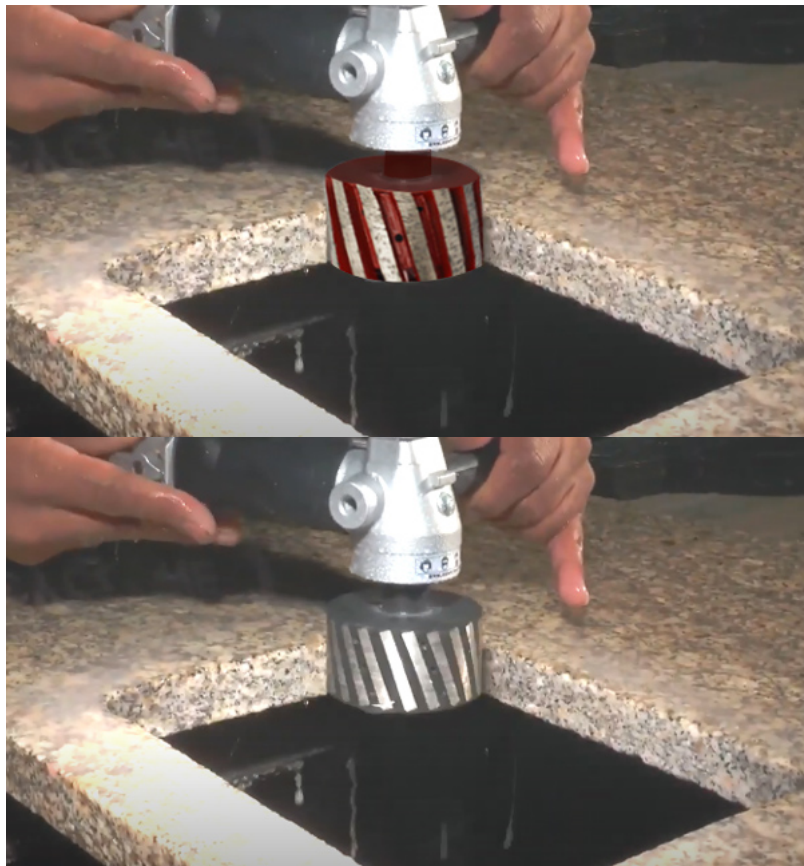
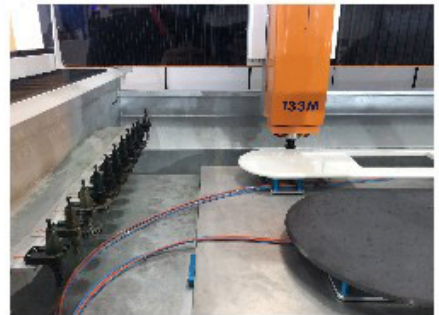
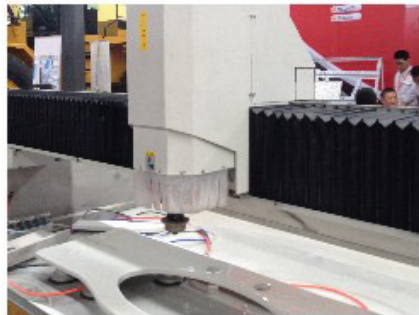
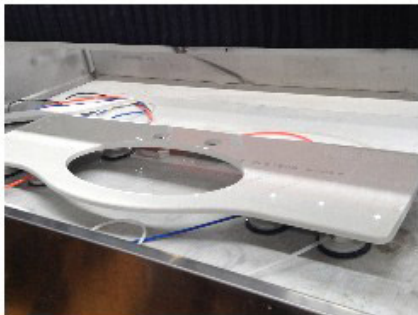
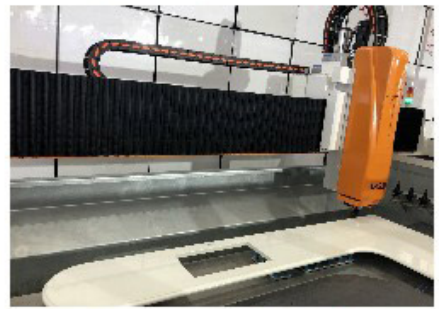



□□□□□□□□



□□□□□□□□□□

1. □□□□□□□□□□□□□□
2. □□□□□□□□□□/□□□□□□□□□□
- 45kg □□□□□□□□□□ Express □□□□□□□□□□□□
4. □□□□□□□□□□□□□□□□□□□□□□□□□□□□

本公司代理各國名廠機械設備，品質優良，價格公道，歡迎各界人士垂詢。LSO 代理各國名廠機械設備，品質優良，價格公道，歡迎各界人士垂詢。

服務項目

DHL、UPS、FedEx、TNT、EMS ETC 等國際快遞

代理各國名廠機械設備，品質優良，價格公道，歡迎各界人士垂詢。CIF 代理各國名廠機械設備，品質優良，價格公道，歡迎各界人士垂詢。

福建

Fujian Nanan *boreway* Machinery Co.,Ltd.

 No.605 Huahui Center, Shuitou Town 362342 Quanzhou, Fujian, China

 **Tel** +86 595-86990206 /  +86 595-86990220

 / **WhatsApp / WECHAT** + 86 18650679939

 **E** boreway@boreway.com

 **Lyon Chang**