

150mm diameter turbo saw blade with narrow teeth

**Specifications:**

150mm diameter turbo saw blade with narrow teeth

1. Suitable for cutting granite, marble, limestone, etc.
2. Suitable for cutting granite, marble, limestone, etc. with narrow teeth.

150mm diameter turbo saw blade with narrow teeth setting

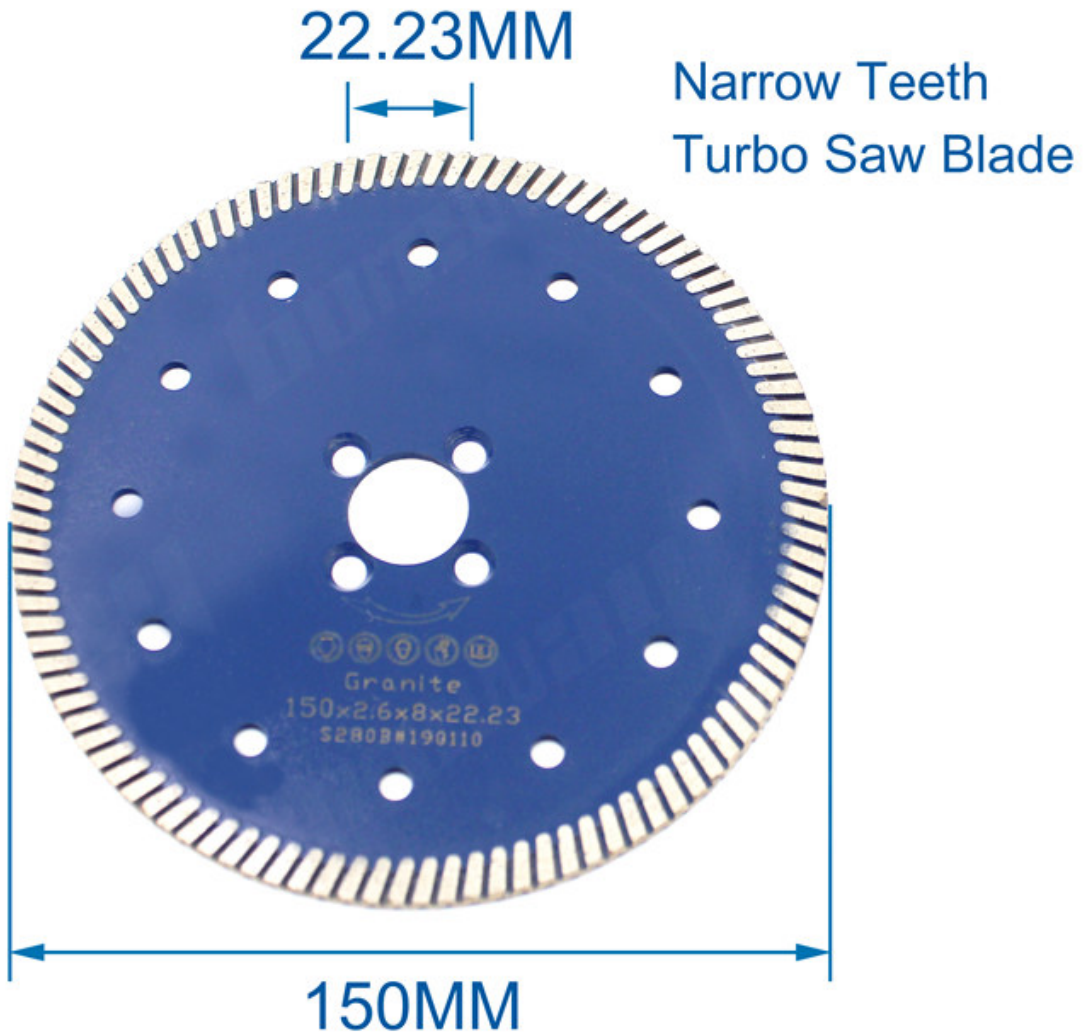

**boreway®**

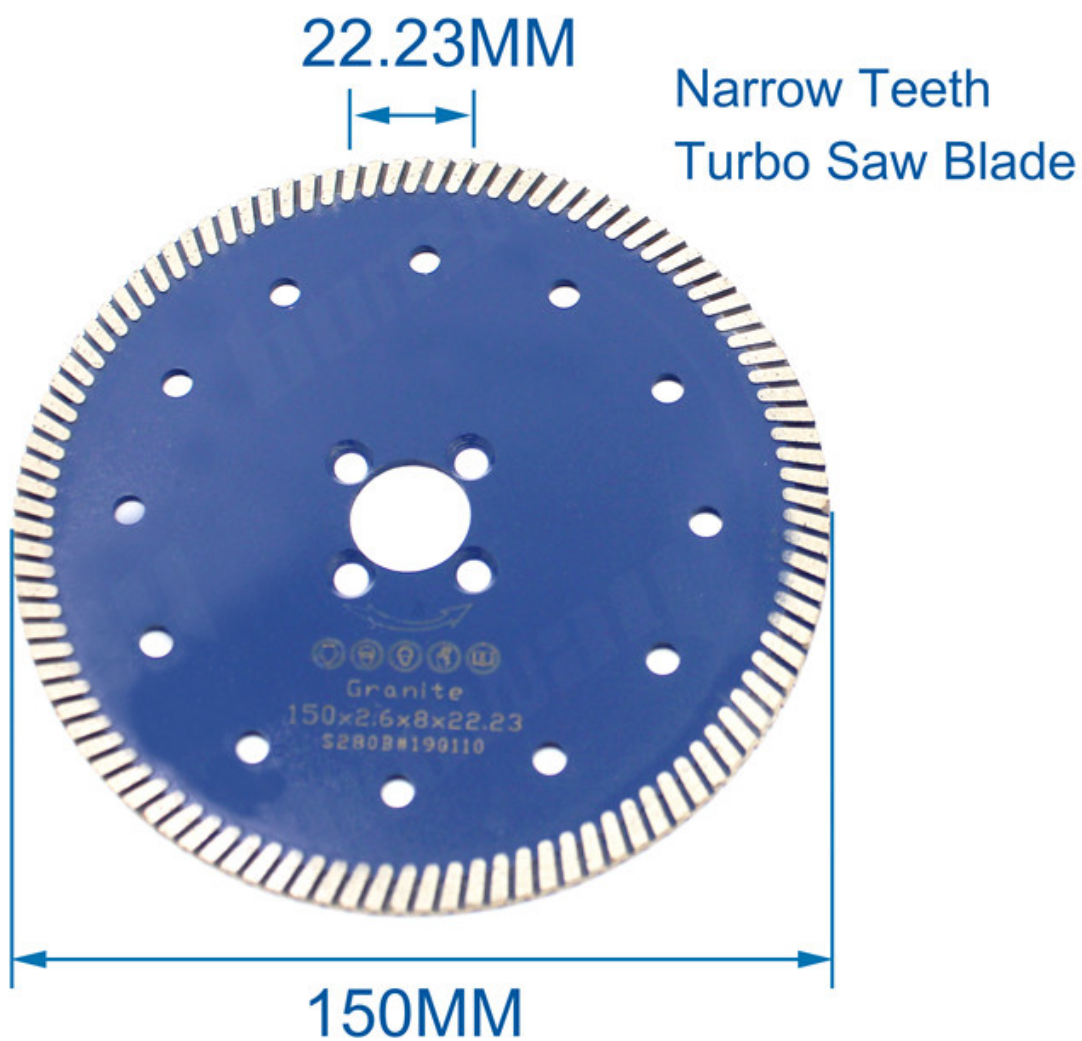

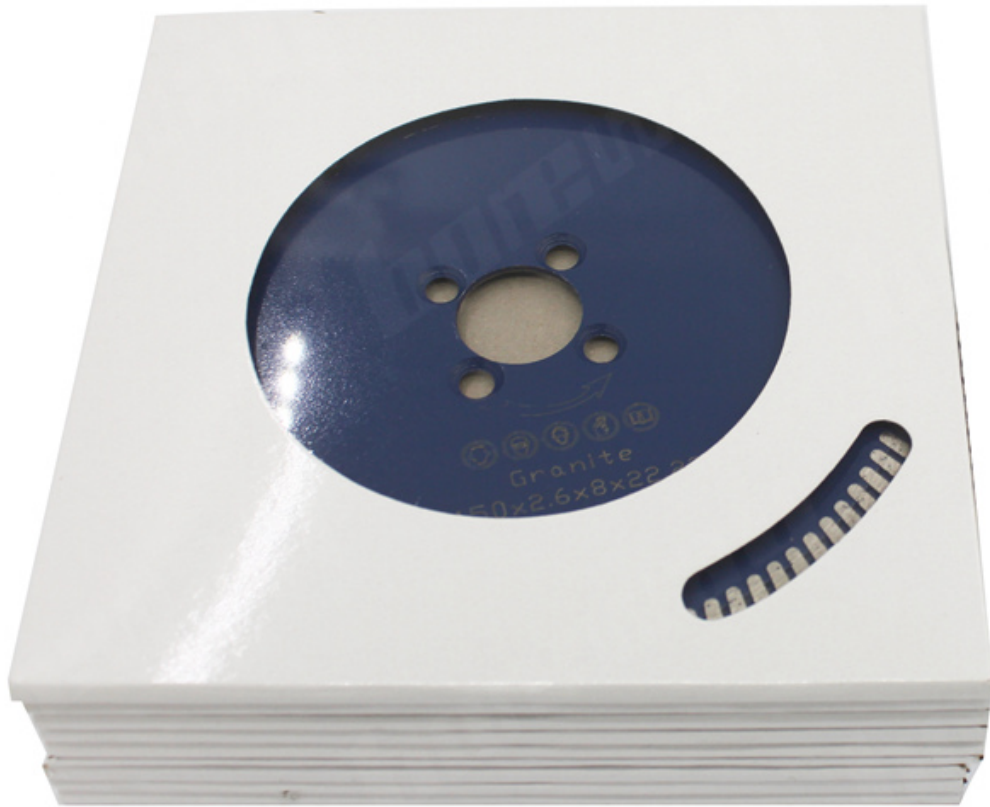

**□□□:**

1. □□□□□□□□ □□ □□□ **150** □□□□ □□□□□□ □□□□ □□□□ □□□□ □□□□ □□□□□□□□□□□□□□
  2. □□□□□ □□ □□□□: □□□□ □□□□□□, □□□□ □□□□□□□
  3. □□□□ □□ □□□□□ □□ □□□□ □□□□ □□ □□□□□ □□□□□□□□□□
  4. □□□□□□□□□□, □□□□□, □□ □□□□ □□□□□□ □□ □□□ □□ □□□ □□ □□□□ □□□□□□
  5. □□□□□□ □□ □□□□□□ □□□□□ □□□□□, □□□□□□ □□□□□□ □□□ □□□□□□, □□□□□ □□□□□ □□ □□□□
- = □□□□□□□□ □□□□□□□□□□ = □□□□□□□□□□□□□□□□ □□□□□□ = □□□□□□ □□ □□□□□□□□ = □□□□□□

**Our factory** use original high grade diamond



pk

**Other factory** mix second diamond selected from waste segment



**Our blade** cutting effect



pk

**Other supplier** blade cutting effect

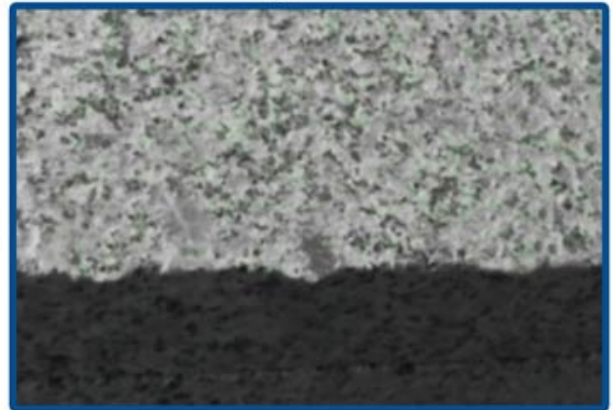

00000:

00000000 00 000 **150** 0000 00000000 0000 000000 000000 00 000000 0000 00 000000 00 00000000  
0000 0000 000 000000 00, 00 000000 0000 00 00000000, 00000 00000000 00 00000, 0000000000000  
0000000, 0000000000, 000000000000, 0000000 00000000 00 00000 0000000 00 000000 00 0000 0000000000 0000

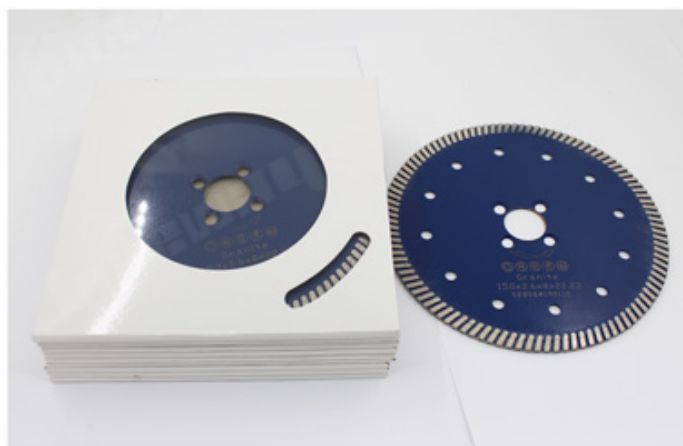
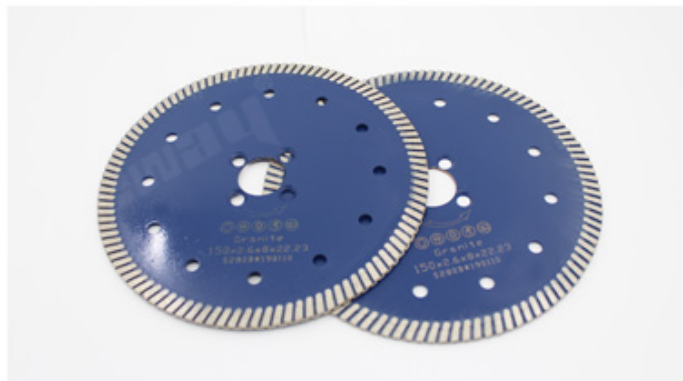
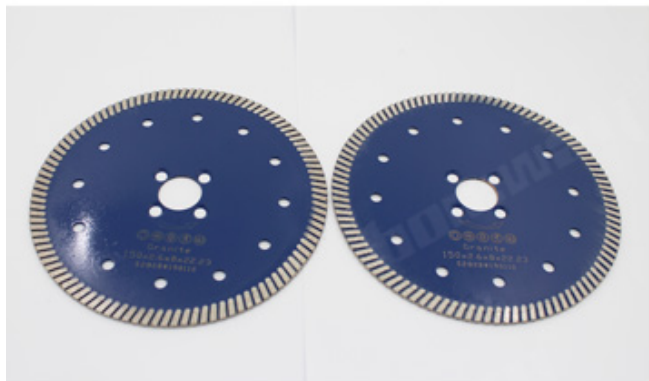

150

4.3	110	32.3	6/8/9	8/10/12		4	105		35	6/8	8/10/12
4.5	115	38.5	8	8/10/12				16/20 22.23 25.4 30			
5	125	37.5	9	8/10/12							
6	150	33.5	12	8/10/12							
7	180	35	14	8/10/12							
8	200	39.2	14	8/10/12							
9	230	34.4	18	8/10/12							





● Cold Press Mschine

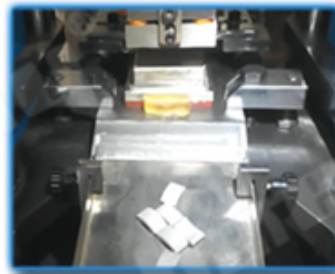

● Fill The Mold



● The Product Polishing



● Hot Press Machinery



● Remove The Mold



● Packing

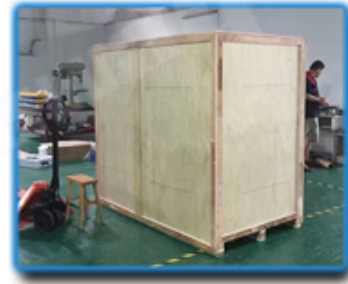
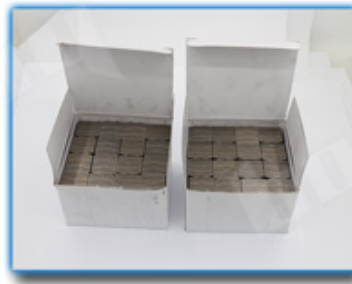

□□□□ □□□ □□ □□□□ □□:

1. □□□□ □□□□□ □□□□□□ □□□□ □□ □□□□, □□□□ □□□□ □□ □□□□□ □□□ □□□□□ □□ □□□ □□□□□□□□ □□□□□ □□□□□,

□□□□ □□□□□ □□□□□□ □□□□ □□□, □□□□□□□ □□□□ □□ □□□□□□ □□ □□□□□ □□□□□□ □□□□□□ □□ □□□□□ □□□□□□ □□□□□□ □□ □□□□□, □□ □□□□□ □□□□□□ □□□□□ □□□□□ □□□□□
2. □□□□ □□ □□□□ □□□□□ □□ □□□□□ □ □□□□ □□ □□□□□□□□□□□□ □□□□ □□ □□□□□ □□ □□□ □□□
3. □□□□□□ □□□□ □□□, □□□□□□ □□ □□□□□□□ □□□□□□, □□□□□□□ □□□□ □□ □□□□ □□□□□, □□□□□□□□□□ □□□□□□□ □□□□□ □□□□□□, □□□□ □□□□□□, □□□□ □□□□□□ □□□□□□□□ □□□□□□□□, □□□□□ □□ □□□□ □□ □□□□□ □□□□□ □□□□□
4. □□□□□ □□ □□□□□□□ □□□ □□□□□□□□□□□ □□□□ □□□□□

□□□□□□□□□□:

□□□ □□□□□□, □□□□□ □□ □□□ □□□□!

□□□□□□□□ □□ □□□ **150** □□□□□ □□□□□□□□ □□□□ □□□□□ □□□□□□□□□□, □□□□□, □□□□□ □□□□□□, □□□□□ □□□□□□, □□□□□□□□□□ □□□□□ □□□□ □□□□ □□□ □□ □□□ □□□□□□□□ □□□

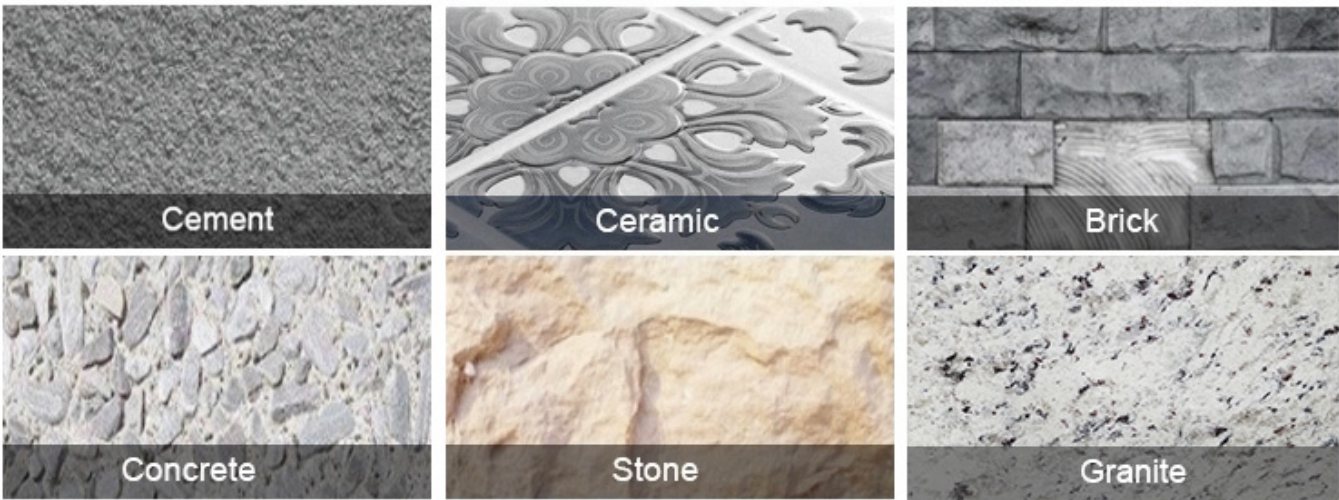

□□□□□ □□□□□:

□□□□□□□□ □□ □□□ **150** □□□□□ □□□□□□□□ □□□□ □□□□□ □□□□□ □□ □□□□ □□□ □□ □□□□□□, □□□□□□□□ □□□□□, □□□□□ □□□□□



Electric circular saw

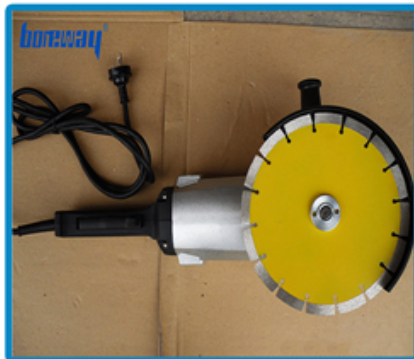

Angle Grinder



Road cutting machine

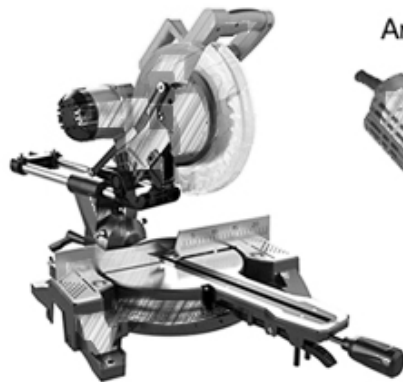

Multi-function cutting machine



□□□□□□□□ □□□□□□□□:





Boreway Machinery Co.,Ltd  
www.diamondtools.top  
www.boreway.net

40x8x10mm □□□□□□ □□□□



Boreway Machinery Co.,Ltd  
www.diamondtools.top  
www.boreway.net

□□□□□□ □□□□□□ □□□□□□

□□□□□ □□□□□ □□□□□:

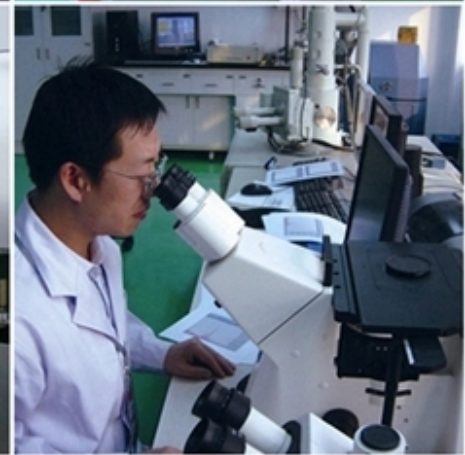





**問 題 一：**

請 簡 述：

1. 請 簡 述 該 展 覽 會 的 展 覽 目 的 及 展 覽 的 重 要 性
2. 請 簡 述 該 展 覽 會 的 展 覽 內 容 及 展 覽 的 特 點
3. 該 展 覽 會 的 展 覽 時 間 為 45 kg, 請 簡 述 該 展 覽 會 的 展 覽 內 容 及 展 覽 的 特 點 (請 簡 述 該 展 覽 會 的 展 覽 內 容 及 展 覽 的 特 點)
4. 該 展 覽 會 的 展 覽 內 容 及 展 覽 的 特 點, 請 簡 述 該 展 覽 會 的 展 覽 內 容 及 展 覽 的 特 點



**000000 0000:**

1. 00 0000 000000: 00 00000000 0000 00 00 000000 00 0000 00 0000 00
2. 0000 00 000000: 00 0000 000000 00 0000 0000 00000000 0000
3. OEM 0000000000: 00 0000 000000 00 000000 00 00000000 00000000 00 0000 0000
4. 000000 00000000: 00 00 0000 00000000 00000000 00000000 0000 000000 0000 000000 0000000000 0000
5. 000000 0000: 00 0000 0000000000 00 0000 0000 00 00000000000000 00 00000000 00 0000 000000 00 0000 0000 000000 0000

**00000000 000000:**

1. 0000 00 00000 00000000 00 0000000 00000 000000 0000, 00 00 0000 0000000000 0000 000000 0000?  
 00 00 0000 00 00000 00 0000 00000000 00 0000 0000, 00 0000 0000 0000000000 00 0000 00 00000000  
 00000, 00000000 00 00 0000 00000 00000 0000000000 00 0000 00000 0000000000 00 00000 00000 0000000000  
 00 000000 00000 0000 00 000000000000 000000 00 8 00 00000 00000000 00 0000 00 00000000 00000 000000  
 0000000000 00000
2. 00 000000 00000 00 0000 0000000 00000000 00 00000 0000?  
 00 00: 000000 0000000 00000000 00000 00000 00000 00000000 00 000000 00 00000 00, 00 000000 0000 00  
 00000000 00000 00000000000 0000000000 00 00000 00000000 000000 000000 00000000 00000000, 00 00000 00000000  
 00000000 00 00000000 00 00000 0000000000 0000000000 00 00000 0000000000 0000000000 00 00000000 00 000000

በገንዘብ ምንጭ ላይ ለተለያዩ ስራዎች የሚያስፈልገውን የገንዘብ መጠን ለማሰጠት ለሚችሉ ገቢዎች ምሳሌ ይጻፉ።

3. በገንዘብ ምንጭ ላይ የሚከተሉት የገንዘብ ምንጮች ምሳሌ ይጻፉ?  
የገንዘብ ምንጭ ላይ የሚከተሉት የገንዘብ ምንጮች ምሳሌ ይጻፉ።