

□□□□□□□□□□□□□□□□□□□□

□□□

- 1. □□□□□□□□ □□□□
- 2. □□□□□□□□□□□□
- 3. □□□□□□□□□□□□□□
- 4. □□□□□□□□□□□□□□□□
- 5. C □□□□□□□□□□□□□□□□□□□□

□□=□□□□=□□□□□□□□=□□□□□= OEM

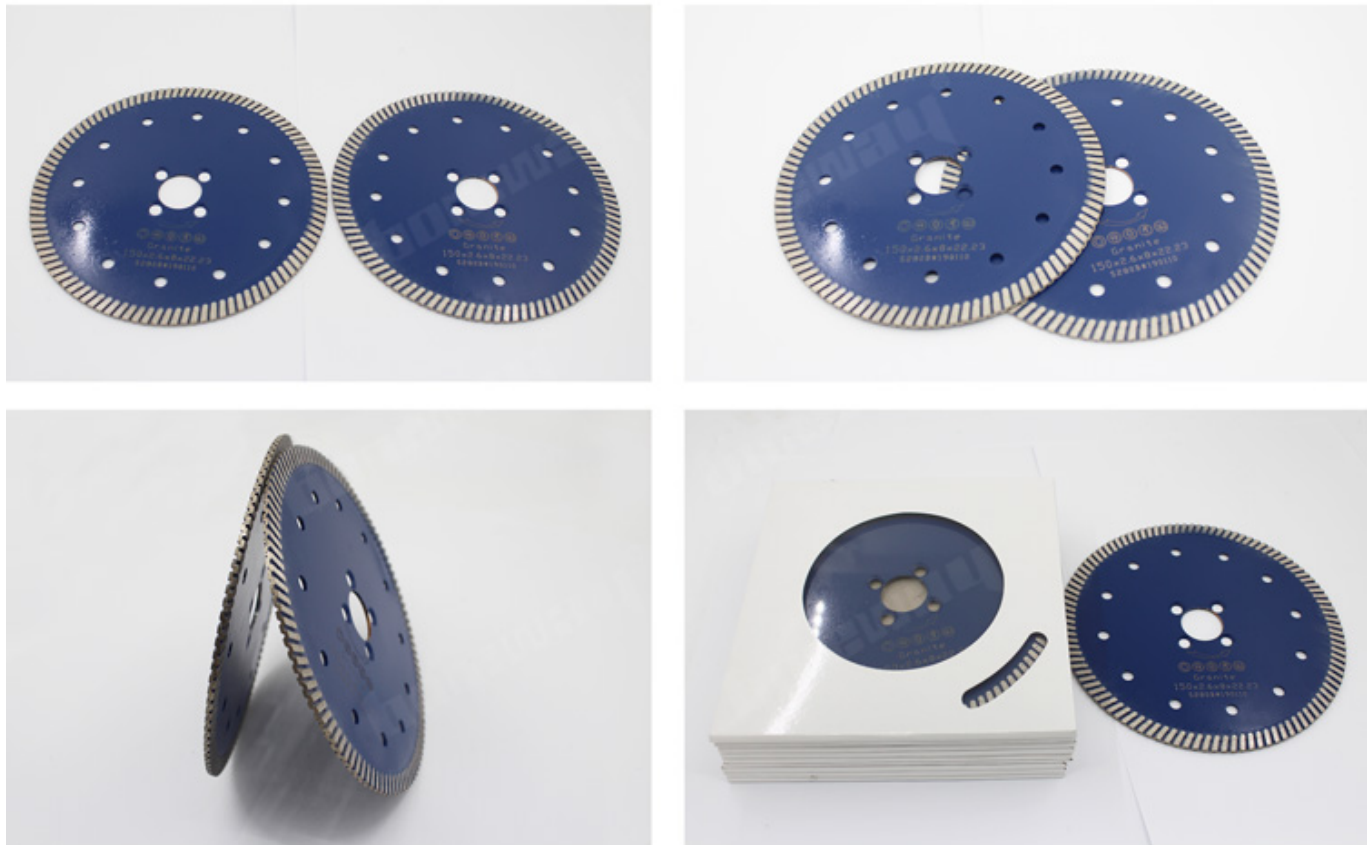

□□□

□□□□□□□□ □□□

□□□

□□□□□□□□

- 1. □□□□□□□□

2. 30x30x10mm Diamond Blending Test

**Our factory** use original high grade diamond



pk

**Other factory** mix second diamond selected from waste segment



**Our blade** cutting effect



pk

**Other supplier** blade cutting effect

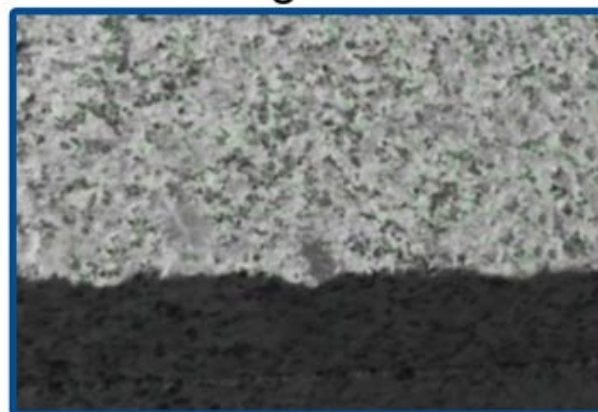

--	--	--	--	--	--	--	--

3. 30x30x10mm Diamond Blending Test

PK	PK	PK	PK	PK	PK	PK	PK	PK	PK
4.3	110	32.2	68/9	2012/8/10	4	105	35	6/8	2012/8/10
4.5	115	38.5	8	2012/8/10					
5	125	37.5	9	2012/8/10					
6	150	33.5	12	2012/8/10					
7	180	35	14	2012/8/10					
8	200	39.2	14	2012/8/10					
9	230	34.4	18	2012/8/10					

3. 30x30x10mm Diamond Blending Test





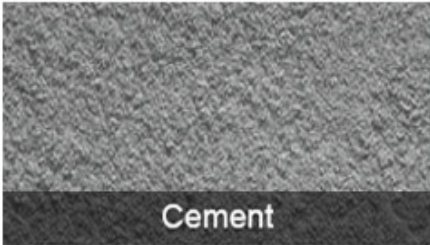

Cement

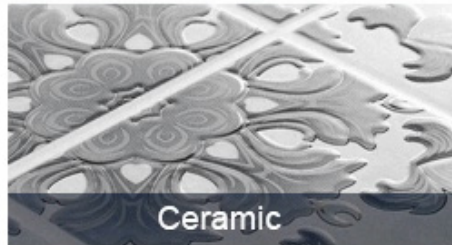

Ceramic

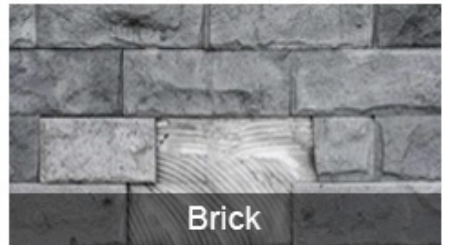

Brick



Concrete



Stone



Granite



□□□□□□□□ □□ □□ □□□□□□□□□□□□□□



Electric circular saw



Angle Grinder



Road cutting machine



Multi-function cutting machine

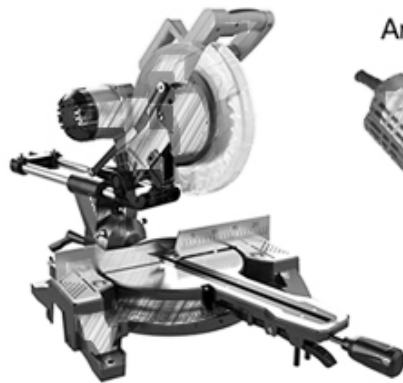



Boreway Machinery Co.,Ltd  
www.diamondtools.top  
www.boreway.net

□□□□□□□□□□



Boreway Machinery Co.,Ltd  
www.fordiamondtools.com  
www.diamondtools.top

300mm□□□□□W□

□□□□□

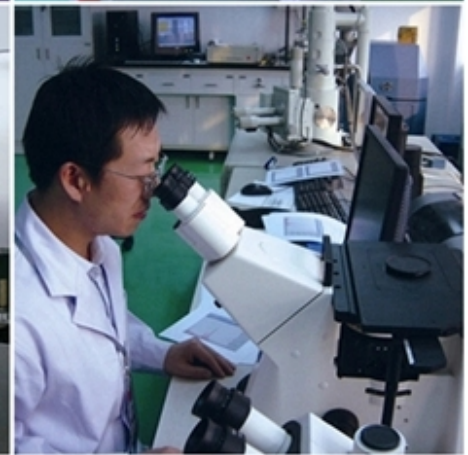





□□□□□□

PS□

1.□□□□□

2.□□□/□□□□□□□□□□□□□□/□□

3.□□45kg□□□□□□□□□□□

4.□□□□□□□□□□□□□



XX

XXXXXX

# Fujian Nanan *boreway*<sup>®</sup> Machinery Co.,Ltd.

 XXXXXXXXXXXXXXXXXXXX605X362342

 XXXX +86X595-86990206 /  XXXX +86X595-86990220

 XXX/ **WhatsApp** /XXXX + 86X 18650679939

 XXXXXX **boreway@boreway.com**

 XXXX