

□□□□□□ □□□□□□□□□□□□



□□□□□□□□□□□□□□□□□□□□

□□□□□□□□

1. □□□□□□□□□□□□□□□□□□□□
□□□□□□□□□□□□□□□□□□

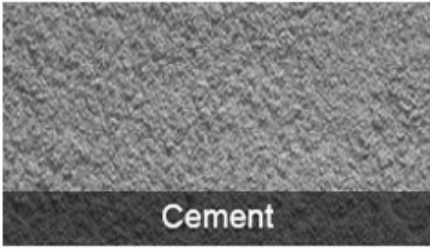

Cement

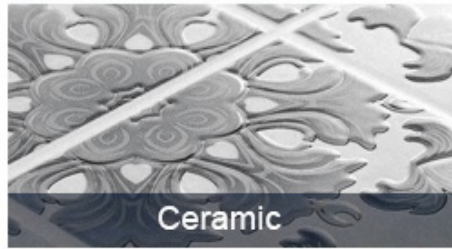

Ceramic

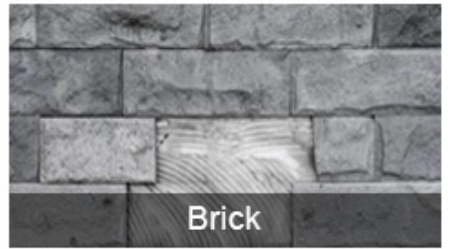

Brick



Concrete



Stone



Granite

□□□□□

□□□□□□□□□□

□□□□□□□□ □□ □□ □□□□□□□□□□□□□□

Electric circular saw



Angle Grinder

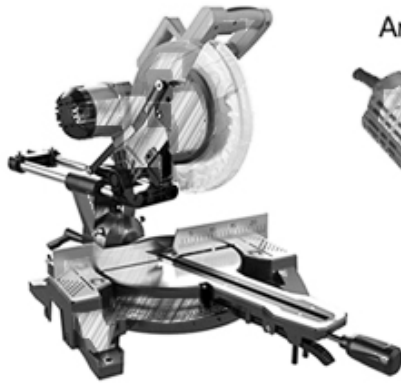

Multi-function cutting machine



Road cutting machine

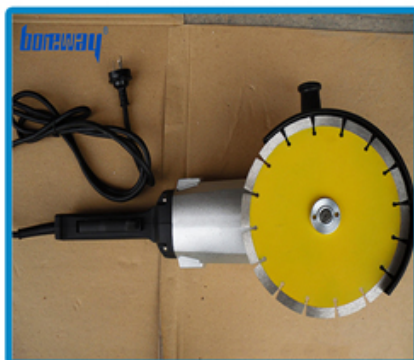

□□□□□



□□□□□□

PS□

1.□□□□□

2.□□□/□□□□□□□□□□□□/□□

3.□□45kg□□□□□□□□□□□□

4.□□□□□□□□□□□□□□

XX

XXXXXX

Fujian Nanan *boreway*[®] Machinery Co.,Ltd.

 XXXXXXXXXXXXXXXXXXXX605X362342

 XXXX +86X595-86990206 /  XXXX +86X595-86990220

 XXX/ **WhatsApp** /XXXX + 86X 18650679939

 XXXXXX **boreway@boreway.com**

 XXXX