

105mm-230mm

1

1. 105mm-230mm

2. 105mm-230mm

3. 105mm-230mm

4. 105mm-230mm

5. C

= = = = OEM

2

105mm-230mm

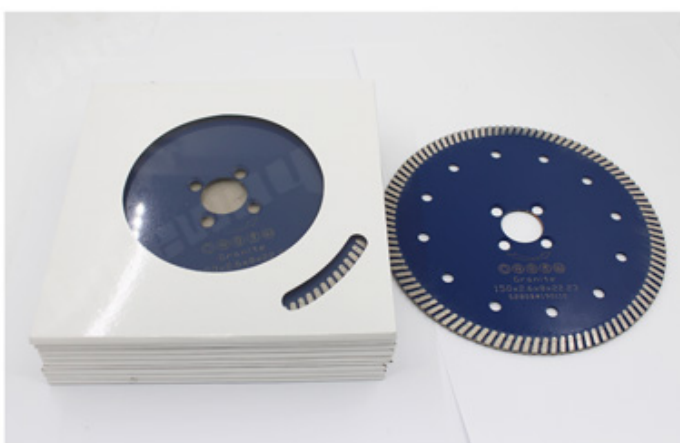
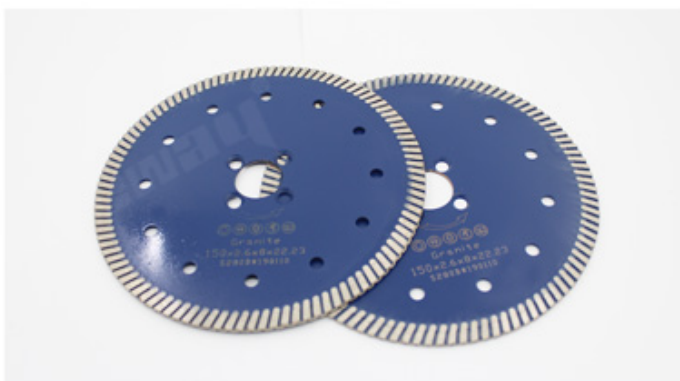

3

105mm-230mm

1. 105mm-230mm

2. 品質比較

**Our factory** use original high grade diamond



pk

**Other factory** mix second diamond selected from waste segment



**Our blade** cutting effect



pk

**Other supplier** blade cutting effect

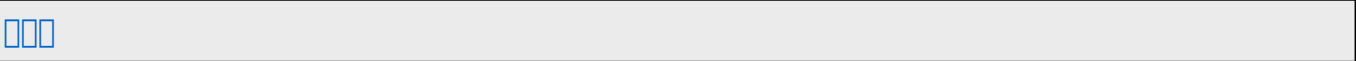
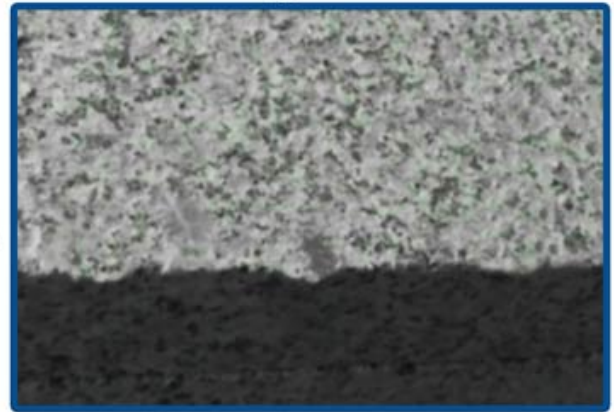

品質比較 品質比較

項目	項目	項目	項目	項目	項目	項目	項目	項目	項目
4.3	110	32.3	6/8/9	2012/8/10	4	105	35	6/8	2012/8/10
4.5	115	38.5	8	2012/8/10					
5	125	37.5	9	2012/8/10					
6	150	33.5	12	2012/8/10					
7	180	35	14	2012/8/10					
8	200	39.2	14	2012/8/10					
9	230	34.4	18	2012/8/10					

品質比較 品質比較



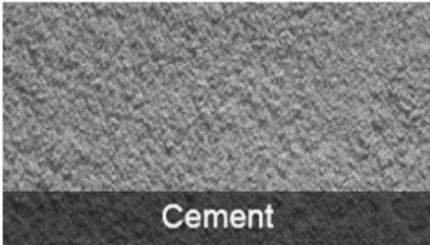

Cement

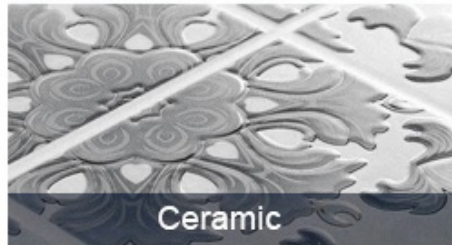

Ceramic

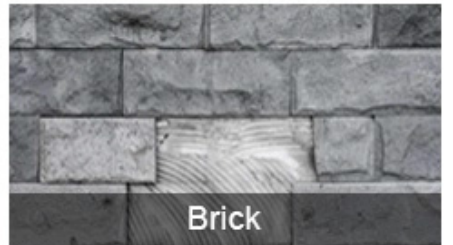

Brick



Concrete



Stone



Granite



□□□□□□□□□□ □□ □□ □□□□□□□□□□□□



Electric circular saw



Angle Grinder



Road cutting machine



Multi-function cutting machine

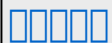
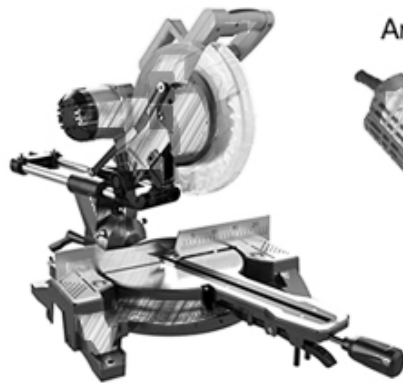



Boreway Machinery Co.,Ltd  
www.diamondtools.top  
www.boreway.net



Boreway Machinery Co.,Ltd  
www.diamondtools.top  
www.boreway.net





□□□□□□

PS□

1.□□□□□

2.□□□/□□□□□□□□□□□□/□□

3.□□45kg□□□□□□□□□□□□

4.□□□□□□□□□□□□□□



XX

XXXXXX

# Fujian Nanan *boreway*<sup>®</sup> Machinery Co.,Ltd.

 XXXXXXXXXXXXXXXXXXXX605X362342

 XXXX +86X595-86990206 /  XXXX +86X595-86990220

 XXX/ **WhatsApp** /XXXX + 86X 18650679939

 XXXXXX **boreway@boreway.com**

 XXXX