

Advantages:

Diamond Finger Drill CNC Bit With Bottom Segment for Suppliers

Recommend Speed:4500 RPM

Feed Speed: 200-450mm/min

- 1.Faster Speed and Lasting longer
- 2. Less Noise and Low Ampere
- 3. Center water feed holes in each bit.
- 4. Please vertical using and add water when grinding,mostly for side grinding.



Boreway Machinery Co.,Ltd
www.diamondtools.top
www.boreway.net

Product Specification:

BOREWAY Specification of **Diamond Finger Drill CNC Bit With Bottom Segment** :

Length:	40mm
Connection:	1/2"G
Diameter:	20mm
Use:	Wet Use
Recommend Speed:	4500 Rpm
Machine:	CNC Machine,Radial Arm machine

Advantage:	High Efficiency and Long Lifespan
Applications:	For Grinding Granite,Engineered Stone and Marble and Other Material

Note:It should be adjusted according to the specific stone, and the cutting depth should not be too deep

Other specifications can be customized according to customer requirements.

Product Descriptions:

1. **Diamond Finger Drill CNC Bit With Bottom Segment** are usually use after diamond core drill bits, fast removing dust,diamond sink wheel.
2. Are ideal for fast stock removal as well as truing up saw lines, which is designed to cut granite, engineered stone and marble,counter tops, kitchen tops and basins.
3. Usually mounted on CNC or Radial Arm machines, for hole grinding, anchor and blind hole.

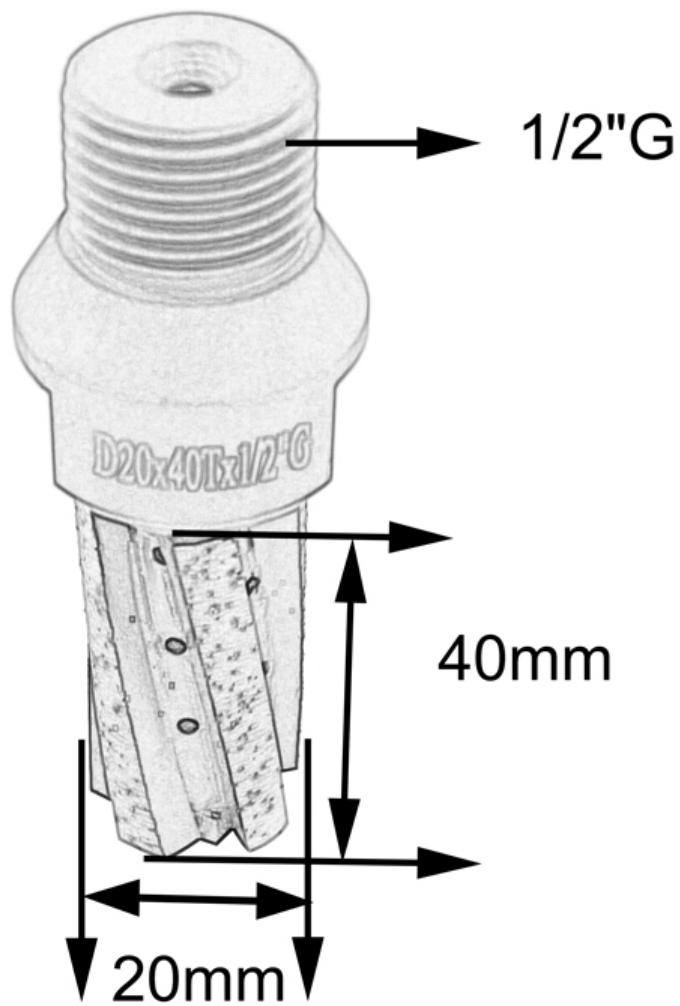

Application:

Diamond Wet Use Finger Bit For Marble Slab for CNC Machine.

Finger Granite Bit with Bottom Segment for Suppliers is made specifically for granite, marble, Quartzite, Quartz, Engineered Stone, and other natural stone materials.

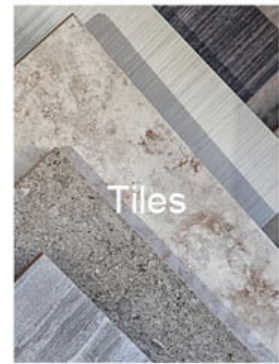
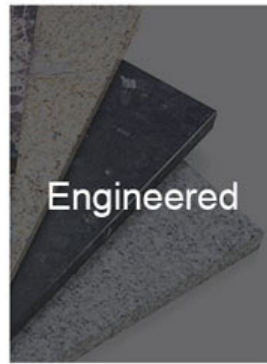
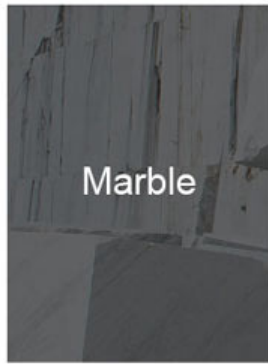

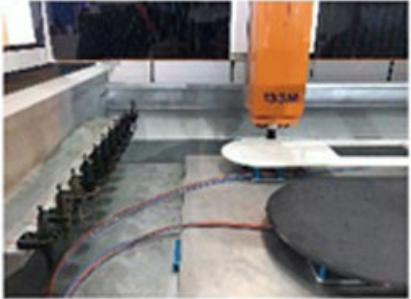
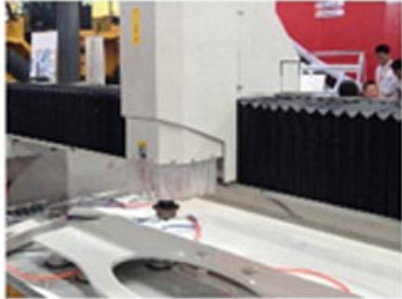
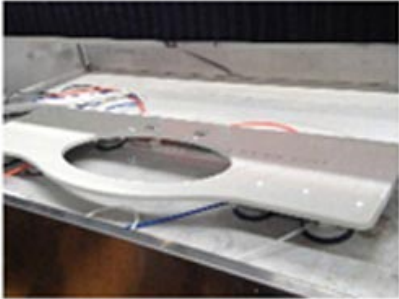
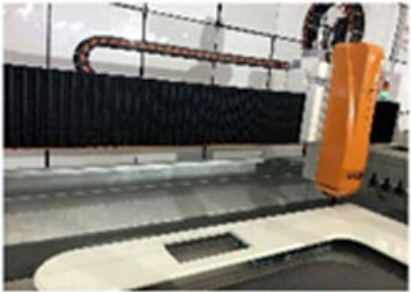

About Us:



Our Service:

1. Low order quantity: It can meet the test order you need.
2. Fast delivery: We get great discounts from freight forwarders.
3. OEM Acceptable: We can produce according to your samples or drawings.
4. Good quality: We have a strict quality control system. Has a good reputation in the market.
5. Good service: We regard our customers as God with a high degree of professionalism and enthusiasm.

Logistics:

Sample order ship by DHL, UPS, FedEx, TNT, EMS etc

For mass order delivery, can be optional with terms of Exwork, FOB, CNF, CIF by air or by sea based on the buyer's forwarder or ours



- For sample or small orders, products could be sent by express, TNT, DHL, UPS, FedEx, EMS etc.
- For large orders, shipping by sea or air is recommended. By our long-term cooperate agent or your appointed forward.
- By sea, port of loading: Shanghai, Ningbo, Xiamen, Qingdao etc.



FAQ:

1. How could we know the quality, if we want to order your products?

Please just test them with a very small order, then you will know the quality. At present, so many people in the world to use Chinese products, because of the high quality and most competitive prices. We are professional manufacturer in supplying diamond tools for more than 8 years. Anyway, confirming our products quality, a small trial order for testing will be necessary.

2. Can you offer free samples?

We don't offer free samples, according to our many years experience, we think people get the samples by paying, they will cherish and appreciate more what they get. But we are willing to give our potential customers a special discount which they are used to do a testing. It is very important to give us feedback, we appreciate it.

3. Does your company accept custom-made?

Surely, we accept it. Including different color, grit etc. We also can mark your own logo and brand on the pad. Any new products you want us to produce for you, just send us your drawing or sample, we will produce the same one. We will not sell this kind of products to other customers only if we get your permission.

Please Note:

1. Please provide items before purchase.
2. Please provide the model number before purchase.
3. Other specifications can be customized according to requirements.

Contact Us:

Fujian Nanan **boreway** Machinery Co., Ltd.



No.605 Huahui Center, Shuitou Town 362342 Quanzhou, Fujian, China

 **TEL:** (+86)595-86990206 /  **Fax:** (+86)595-86990220

 **Mobile/WhatsApp/Wechat:** (+ 86) 18650679939

 **E-mail:** boreway01@boreway.com

 **Lyon Chang**